



# PŘEHLED PRODUKTŮ



**MEGADYNE**

Megadyne je jedním z nejvýznamnějších výrobců řemenů nejvyšší kvality v Evropě a ve světě.

Úspěch společnosti je založen na neustálém vývoji materiálů ve spojení s požadavky moderních technologií a používanými systémy s extrémně vysokou hladinou specializace, která se aplikuje ve všech výrobních technologiích. Této skutečnosti bylo dosaženo vzhledem k velkému množství rozdílných požadavků na řemeny.

Nejvyšší stupeň kvality, který se dosahuje při výrobě řemenů je dále garantovaný nepřetržitým rozšiřováním aktivit ve vývoji. Široký rozsah vnitřních procesů při zkouškách a testování má na starosti velmi moderně vybavené vývojové a zkušební oddělení.

Megadyne, se svým zaměřením na potřeby zákazníků, se stává technologickým partnerem v celé škále pohonových systémů a soustředí se jak na proces výroby, tak na systém kvality. Na základě této filozofie jsou všechny naše hlavní výrobní závody držiteli certifikátů systémů kvality, které se neustále obnovují.













MEGADYNE RUBBER S.A.  
SPAIN



MEGADYNE s.r.l.  
ITALY - MATHI



MEGADYNE S & D s.r.l.  
PRODUCTION PLANT  
OF CAPONAGO  
ITALY - CAPONAGO

Výrobní a distribuční závody		2
	<b>KLÍNOVÉ ŘEMENY</b> Neoprenové klínové řemeny	4
	<b>POLY-V DRÁŽKOVÉ ŘEMENY</b> Neoprenové drážkové řemeny	16
	<b>ISORAN SYNCHRONNÍ ŘEMENY</b> Nekonečné neoprenové ozubené řemeny	18
	<b>NEOPRENOVÉ LINEÁRNÍ ŘEMENY</b> Ozubené gumové řemeny v metráži	24
	<b>MEGAFLAT</b> PU a gumové ploché nekonečné řemeny	26
	<b>MEGAPOWER</b> PU nekonečné ozubené řemeny	28
	<b>MEGALINEAR</b> PU ozubené řemeny v metráži	32
	<b>MEGAFLEX</b> PU nekonečné ozubené řemeny - nestandardní délky	36
	<b>MEGARIB</b> PU nekonečné drážkové řemeny	40
	<b>SPECIAL</b> Speciální rozteče, povrchové úpravy a profily	42
	<b>ŘEMENICE/UPÍNACÍ DESKY</b> Ozubené řemenice standardní, nestandardní a upínací desky	44
<b>Katalogy Megadyne</b>		88

# VÝROBNÍ A DISTRIBUČNÍ ZÁVODY

Společnost **Megadyne** zahájila výrobu pohonových řemenů v roce 1957. Neustálý výzkum a vývoj vyústil ve vytvoření širokého sortimentu kvalitních produktů. To předurčuje **Megadyne** na pozici jednoho ze světových lídrů ve výrobě polyuretanových řemenů, neoprenových řemenů a řemenic, nabízející na trhu kompletní převodový systém. Produkty **Megadyne** jsou využitelné ve velkém množství průmyslových převodových aplikací, při přenosu síly, při synchronizaci převodů, při přepravě různých produktů a lineárním pohonování. Výrobní závody se nacházejí v těchto lokalitách: Mathi a Miláno (Itálie), St. Jean de Maurienne a Bondoufle (Francie), Ulm (Německo), Pineville (USA), Barcelona (Španělsko) a WuXi (Čína). Posláním **Megadyne** je neustále usilovat o dosažení nejkvalitnějších produktů pro všechna průmyslová odvětví. Výzkumná a vývojová oddělení **Megadyne** jsou v permanentní spolupráci s technickými odděleními našich zákazníků, podporují existující řešení a napomáhají při vývoji nových aplikací. Naším cílem je uspokojit všechny potřeby našich zákazníků. Pro zabezpečení technické podpory naše oddělení technického vývoje a výzkumu neustále vyvíjejí nové materiály a pravidelně obnovují výrobní technologie. Díky tomu je vývoj nových produktů mnohem účinnější. Celosvětová distribuční síť garantuje technickou a logistickou podporu na velmi vysoké úrovni. **Megadyne**, díky této síti, neustále zvyšuje svůj podíl na celosvětovém trhu. Společnost MEGADYNE CZ s.r.o. byla založena v roce 2001 a za krátkou dobu se stala strategickým hráčem v oblasti řemenů a pásů na českém trhu.

Přímá zastoupení **Megadyne**:

MEGADYNE S.p.A. - Mathi (TO) - ITALY

MEGADYNE AMERICA LLC - Pineville NC - USA

MEGADYNE CE - Bydgoszcz - POLAND

MEGADYNE CHINA - Foshan Guangdong - CHINA

MEGADYNE CZ - Prague - CZECH REPUBLIC

MEGADYNE DO BRASIL LTDA - San Paulo - BRASIL

MEGADYNE EE - Minsk - BELARUS

MEGADYNE FRANCE - Bondoufle - FRANCE

MEGADYNE GmbH - Borchten - GERMANY

MEGADYNE HU KFT - Budapest - HUNGARY

MEGADYNE RUBBER - Vilanova I La Geltru

(Barcelona) - SPAIN

MEGADYNE S&D - Robassomero (TO) - ITALY

MEGADYNE UK - Leeds - UK

MEGADYNE MIDDLE EAST - Dubai - UAE

MEGADYNE NORDIC AB - Sollentuna - Sweden

JASON INDUSTRIAL Inc - New Jersey - USA

## Centrála – Mathi (Itálie)

Výroba extrudovaných řemenů



## Nový výrobní závod – Mathi (Itálie)

Výroba polyuretanových extrudovaných řemenů



## Megadyne S&D – Miláno (Itálie)

Výroba standardních a speciálních řemenic





**Megadyne America LLC – Pineville (USA)**

Výroba PU řemenů v metráži



**Megadyne China – WuXi (Čína)**

Výroba klínových řemenů



**Megadyne France SA – Bondoufle (Francie)**

Výroba speciálních řemenic



**Megadyne France – St. Jean de Maurienne (Francie)** Výroba nekonečných polyuretanových řemenů



**Megadyne GmbH – Ulm (Německo)**

Výroba plochých nekonečných řemenů



**Megadyne Rubber SA – Barcelona (Španělsko)**

Výroba klínových řemenů, PV-drážkových řemenů a gumových ozubených řemenů



# KLÍNOVÉ ŘEMENY Neoprenové klínové řemeny



## **OLEOSTATIC®**

Standardní hladký klínový řemen



## **SP**

Klínový řemen opletený



## **KOMPATTEX®**

Klínový řemen opletený



## **ESAFLEX®**

Oboustranný klínový řemen



## **XDV2**

Extra silný klínový řemen



## **LINEA X**

Řezaný klínový řemen

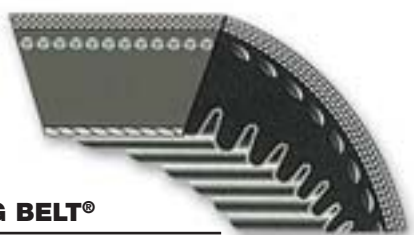

## **GOLD LABEL COG BELT®**

Klínový řemen neopletený



## **KOMPATTEX® COG BELT®**

Řezaný klínový řemen



## **VARISECT**

Variátorový řemen



## **PLURIBAND®**

Násobný klínový řemen



**Klíňové řemeny** se vyrábějí z polybutadienových komponent. Velké množství vyráběných rozměrů umožňuje aplikovat klíňové řemeny Megadyne na všechny typy průmyslových zařízení. Aplikovaná výrobní technologie umožňuje dosáhnout takové přesnosti rozměrů, že jsou vhodné i pro násobné převody.

Vlastnosti **klíňových řemenů**:

#### **Mechanické vlastnosti**

- hladký start a běh
- velký rozsah hnacích rychlostí při využití standardních elektrických motorů
- nenáročná údržba
- vysoká efektivita
- bez nutnosti mazání
- extrémně široký rozsah přenosu síly
- tlumení vibrací mezi hnací a hnanou řemenicí
- tichý chod
- dlouhá životnost
- snadná instalace
- redukce rozměrů u hnacích pohonů



#### **Chemické vlastnosti**

- rozsah pracovních teplot -30 °C až +70 °C
- odolnost vůči olejům a průmyslovým mazivům
- antistatické provedení

#### **XDV2 řemeny**

XDV2 řemeny byly vytvořeny pro malé průměry hnacích řemenic s vysokým bodem teplotního zatížení, kombinovaného s vysokou hodnotou vlhkosti. Řemeny jsou vysoce odolné nejtěžším pracovním podmínkám, jako jsou například znečištěné převody od mazadel a olejů, kde dochází také ke znečištění pískem. Díky jejich charakteristice řemeny XDV2 perfektně odpovídají požadavkům rychlospojkových převodů, kde díky aramidovým kordům chrání řemeny proti šokovým zatížením a udržují jejich konstantní délku.

#### **Pozn.**

V katalogu uvedené délky klíňových řemenů Oleostatic jsou orientační. Konkrétní rozměry se mohou lišit od hodnot uváděných v tabulkách tak, jak to umožňují normy "RMA Standard tolerances". Tento rozměr je pak stejný pro každý typ řemene.





# KLÍNOVÉ ŘEMENY Neoprenové klínové řemeny

## OLEOSTATIC

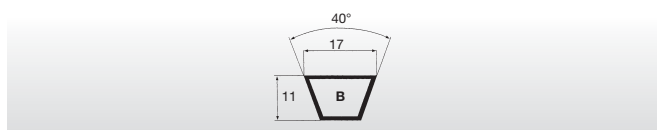
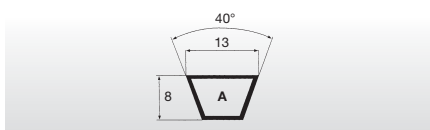
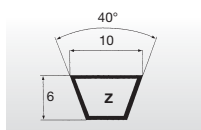

SEKCE Z		SEKCE A		SEKCE A		SEKCE B		SEKCE B		SEKCE B	
Označení	vnitřní délka (mm)	Označení	vnitřní délka (mm)	Označení	vnitřní délka (mm)	Označení	vnitřní délka (mm)	Označení	vnitřní délka (mm)	Označení	vnitřní délka (mm)
Z 16*	410	A 15*	382	A 71	1800	B 22 1/2	570	B 78	1981	B 228	5757
Z 17 1/4*	440	A 18	457	A 72	1825	B 23	587	B 79	2000	B 229	5782
Z 18	460	A 19	480	A 73	1854	B 24	612	B 80	2032	B 237	6000
Z 19	480	A 20	508	A 74	1880	B 25	637	B 81	2060	B 240	6062
Z 19 1/2	500	A 21	535	A 75	1900	B 26	650	B 82	2083	B 248	6267
Z 20	508	A 22	560	A 76	1930	B 27	686	B 83	2108	B 255	6442
Z 20 1/2	520	A 23	587	A 77	1956	B 28	710	B 83 1/2	2120	B 259	6542
Z 21 1/4*	540	A 23 1/2	600	A 78	1980	B 28 1/2	725	B 84	2134	B 265	6700
Z 21 1/2	545	A 24	610	A 79	2000	B 29	737	B 85	2160	B 270	6825
Z 22	560	A 24 1/2	620	A 80	2032	B 29 1/2	750	B 86	2187	B 276	7000
Z 22 1/4	565	A 24 3/4	630	A 81	2060	B 30	762	B 86 1/2	2200	B 285	7207
Z 22 1/2	575	A 25	637	A 82	2083	B 31	787	B 87	2215	B 300	7587
Z 23	585	A 25 1/2	647	A 83	2100	B 31 1/2	800	B 88	2240	B 315	7967
Z 23 1/2	600	A 26	660	A 83 1/2	2120	B 32	812	B 89	2261	B 330	8347
Z 23 3/4	605	A 26 1/2	670	A 84	2134	B 32 1/4	822	B 90	2286	B 360	9107
Z 24	610	A 27	686	A 85	2160	B 32 1/2	825	B 91	2312	B 361	9132
Z 24 3/4	630	A 27 1/2	700	A 86	2187	B 33	838	B 92	2337	B 366	9262
Z 25	635	A 28	710	A 87	2212	B 33 1/2	850	B 93	2360	B 394	9972
Z 25 1/2	650	A 28 1/2	724	A 88	2240	B 34	867	B 94	2388	B 433	10957
Z 26	660	A 29	737	A 89	2267	B 34 1/2	875	B 95	2413	B 472	11957
Z 26 1/2	670	A 29 1/2	750	A 90	2286	B 35	889	B 96	2438		
Z 27	685	A 30	767	A 91	2311	B 35 1/2	900	B 96 1/2	2450		
Z 27 1/2	700	A 30 1/2	775	A 92	2337	B 35 3/4	907	B 97	2465		
Z 28	710	A 31	787	A 93	2360	B 36	917	B 98	2500		
Z 28 1/2	725	A 31 1/2	800	A 94	2388	B 36 1/2	925	B 99	2515		
Z 29	735	A 32	813	A 95	2413	B 36 3/4	937	B 100	2540		
Z 29 1/2	750	A 32 1/2	825	A 96	2438	B 37	942	B 101	2565		
Z 30	765	A 33	838	A 97	2464	B 37 1/2	950	B 102	2600		
Z 30 1/2	775	A 33 1/4	847	A 98	2500	B 38	965	B 103	2616		
Z 30 3/4	785	A 33 1/2	850	A 100	2540	B 38 1/2	975	B 104	2650		
Z 31	787	A 34	867	A 102	2591	B 39	990	B 105	2667		
Z 31 1/2	800	A 34 1/2	875	A 104	2650	B 39 1/2	1000	B 106	2700		
Z 32	815	A 35	900	A 105	2667	B 40	1016	B 107	2718		
Z 32 1/2	825	A 36	914	A 107	2725	B 40 1/2	1030	B 108	2750		
Z 33	840	A 36 1/2	925	A 108	2743	B 41	1040	B 110	2800		
Z 33 1/2	850	A 37	942	A 110	2800	B 41 1/2	1050	B 112	2845		
Z 34	865	A 37 1/4	946	A 112	2845	B 41 3/4	1060	B 114	2900		
Z 34 1/4	870	A 37 1/2	950	A 113	2870	B 42	1067	B 115	2921		
Z 34 1/2	875	A 38	965	A 114	2896	B 42 1/2	1075	B 116	2950		
Z 35	890	A 38 1/2	975	A 116	2946	B 43	1090	B 118	3000		
Z 35 1/2	900	A 39	992	A 118	3000	B 43 1/2	1100	B 120	3048		
Z 36	915	A 39 1/2	1000	A 120	3048	B 44	1120	B 124	3150		
Z 36 1/2	925	A 40	1016	A 124	3150	B 44 1/4	1127	B 126	3200		
Z 36 3/4	935	A 40 1/2	1030	A 128	3250	B 45	1142	B 127	3227		
Z 37	945	A 41	1041	A 130	3302	B 46	1175	B 128	3250		
Z 37 1/2	950	A 41 1/2	1050	A 132	3350	B 46 1/2	1180	B 130	3302		
Z 38	965	A 41 3/4	1060	A 134	3404	B 46 3/4	1187	B 131	3327		
Z 38 1/4	975	A 42	1067	A 136	3454	B 47	1200	B 132	3350		
Z 39	1000	A 42 1/2	1075	A 140	3550	B 47 1/4	1202	B 133	3378		
Z 40	1016	A 43	1100	A 144	3658	B 47 1/2	1215	B 134	3407		
Z 40 1/2	1030	A 43 1/2	1105	A 147	3737	B 48	1225	B 135	3429		
Z 41	1040	A 43 3/4	1111	A 148	3750	B 49	1250	B 136	3450		
Z 41 1/2	1050	A 44	1120	A 155	3937	B 50	1275	B 140	3550		
Z 41 3/4	1060	A 44 1/2	1132	A 158	4000	B 51	1300	B 144	3658		
Z 42	1070	A 45	1143	A 162	4115	B 52	1320	B 147	3737		
Z 42 1/2	1080	A 45 1/2	1150	A 167	4250	B 53	1350	B 148	3750		
Z 43	1090	A 46	1168	A 173	4394	B 53 1/2	1360	B 151	3850		
Z 43 1/4	1100	A 46 1/2	1180	A 180	4572	B 54	1372	B 152	3861		
Z 44	1120	A 47	1200	A 187	4750	B 55	1400	B 154	3912		
Z 45	1145	A 48	1220	A 197	5000	B 55 1/2	1412	B 155	3950		
Z 46	1180	A 48 1/4	1225	A 217	5477	B 56	1422	B 157	3987		
Z 47	1194	A 49	1250			B 57	1450	B 158	4000		
Z 48	1225	A 50	1270			B 58	1473	B 161	4087		
Z 49	1245	A 51	1300			B 59	1500	B 162	4115		
Z 50	1270	A 51 1/2	1307			B 60	1525	B 163	4142		
Z 50 1/2	1285	A 52	1320			B 61	1550	B 165	4200		
Z 51	1300	A 52 1/2	1337			B 62	1575	B 167	4250		
Z 52	1320	A 53	1346			B 63	1600	B 168	4267		
Z 53	1345	A 53 1/4	1355			B 64	1625	B 173	4394		
Z 54	1371	A 54	1372			B 64 1/2	1642	B 175	4450		
Z 55	1400	A 55	1400			B 65	1650	B 177	4500		
Z 56	1422	A 56	1422			B 66	1676	B 180	4572		
Z 57	1450	A 57	1450			B 66 1/2	1692	B 186	4727		
Z 59	1500	A 58	1475			B 67	1700	B 187	4750		
Z 59 1/2	1515	A 59	1500			B 67 1/4	1712	B 188	4777		
Z 61	1550	A 60	1525			B 68	1725	B 192	4877		
Z 62	1575	A 61	1550			B 69	1750	B 195	4953		
Z 63	1600	A 62	1575			B 69 1/2	1761	B 197	5000		
Z 65	1651	A 63	1600			B 70	1775	B 204	5182		
Z 66	1675	A 64	1625			B 71	1800	B 208	5300		
Z 67	1700	A 65	1650			B 72	1829	B 210	5334		
Z 68 1/2	1740	A 66	1676			B 73	1850	B 217	5507		
Z 69	1750	A 67	1700			B 74	1880	B 221	5577		
Z 71	1803	A 68	1725			B 75	1900	B 223	5632		
		A 69	1750			B 76	1930	B 224	5657		
		A 70	1775			B 77	1950	B 225	5682		



## OLEOSTATIC

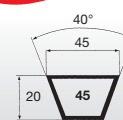
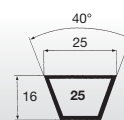
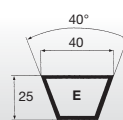
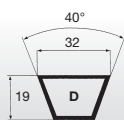
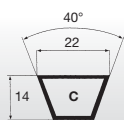

### SEKCE C

Označení	vnitřní délka (mm)
C 33 3/4	858
C 37 1/2	950
C 39 3/4	1013
C 43	1090
C 46	1168
C 48	1220
C 49	1250
C 51	1295
C 52	1320
C 53	1350
C 54	1372
C 55	1400
C 56	1425
C 59	1500
C 60	1524
C 61	1560
C 62 1/4	1583
C 63	1600
C 65	1650
C 67	1700
C 68	1727
C 70	1778
C 71	1798
C 75	1900
C 78	1978
C 80	2032
C 81	2057
C 83	2108
C 84	2134
C 85	2159
C 86	2184
C 87	2208
C 88	2235
C 89	2261
C 90	2286
C 93	2360
C 94	2388
C 95	2413
C 96	2438
C 97	2462
C 98	2500
C 99	2525
C 100	2540
C 101	2560
C 102	2591
C 104	2642
C 105	2667
C 106	2692
C 108	2750
C 110	2800
C 111	2818
C 112	2845
C 112 1/2	2858
C 114	2888
C 115	2921
C 116	2950
C 117	2965
C 118	3000
C 120	3048
C 124	3150
C 126	3200
C 128	3250
C 130	3302
C 132	3350
C 134	3404
C 136	3456
C 138	3498
C 140	3550
C 142	3607
C 144	3658
C 147	3733
C 148	3750
C 150	3808
C 153	3902
C 158	4000
C 160	4064
C 161 1/2	4100
C 162	4115
C 165	4193
C 166	4216
C 168	4267
C 173	4394
C 177	4500
C 180	4572
C 187	4750
C 195	4953

### SEKCE C

Označení	vnitřní délka (mm)
C 197	5000
C 204	5182
C 208	5300
C 210	5334
C 216	5486
C 220	5550
C 222	5600
C 225	5678
C 228	5753
C 236	6000
C 238	6045
C 240	6062
C 248	6263
C 250	6300
C 255	6438
C 265	6700
C 270	6822
C 276	6973
C 280	7100
C 285	7203
C 297	7500
C 300	7582
C 303	7650
C 314	7976
C 316	8000
C 330	8382
C 336	8500
C 360	9107
C 394	10000
C 420	10632
C 424	10733

### SEKCE D

Označení	vnitřní délka (mm)
D 98	2500
D 104	2650
D 110	2800
D 118	3000
D 120	3048
D 124	3150
D 128	3251
D 136	3454
D 137	3475
D 140	3550
D 144	3658
D 154	3914
D 158	4013
D 162	4115
D 170	4310
D 173	4394
D 177	4500
D 180	4572
D 187	4750
D 195	4953
D 197	5000
D 204	5182
D 205	5209
D 207	5259
D 210	5334
D 223	5600
D 225	5659
D 236	5940
D 240	6039
D 248	6244
D 250	6294
D 255	6424
D 266	6700
D 270	6804
D 282	7100
D 285	7184
D 298	7500
D 300	7565
D 314	7924
D 316	7974
D 326	8224
D 330	8329
D 345	8709
D 360	9090
D 390	9849
D 394	10000
D 420	10624
D 441	11200
D 480	12139
D 510	12897
D 540	13659
D 600	15184

### SEKCE E

Označení	vnitřní délka (mm)
E 180	4575
E 197	5000
E 220	5600
E 226	5660
E 240	6015
E 248	6220
E 280	7100
E 285	7160
E 295	7500
E 300	7540
E 316	7950
E 330	8305
E 345	8685
E 354	9000
E 360	9065
E 394	9930
E 420	10600
E 441	11200
E 480	12115
E 492	12500
E 540	13635
E 600	15160

### SEKCE 25

Označení	vnitřní délka (mm)
25	1800
25	1900
25	1950
25	2000
25	2050
25	2120
25	2200
25	2240
25	2325
25	2360
25	2450
25	2500
25	2650
25	2700
25	2800
25	2950
25	3000
25	3150
25	3300
25	3350
25	3550
25	3750
25	3950
25	4000
25	4250
25	4450
25	4500
25	4750
25	5000
25	5300
25	5600
25	5700
25	6000
25	6300
25	6500
25	6700
25	7100
25	7500
25	8000
25	8500
25	9000
25	9500
25	10000

### SEKCE 45

Označení	vnitřní délka (mm)
45	2000
45	2300
45	2500
45	2650
45	2750
45	2850
45	3000
45	3150
45	3250
45	3300
45	3500
45	3750
45	4000

## OLEOSTATIC

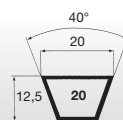

### SEKCE 20

Označení	vnitřní délka (mm)
20	1800
20	1875
20	1900
20	1925
20	1950
20	2000
20	2050
20	2120
20	2200
20	2240
20	2360
20	2500
20	2600
20	2650
20	2800
20	3000
20	3150
20	3250
20	3350
20	3450
20	3550
20	3650
20	3750
20	4000
20	4250
20	4500
20	4750
20	5000
20	5300
20	5600
20	6000

## OLEOSTATIC

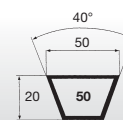

### SEKCE 50

Označení	vnitřní délka (mm)
50	2000
50	2050
50	2150
50	2300
50	2500
50	2650
50	2750
50	2850
50	2870
50	3000
50	3150
50	3250
50	3300
50	3500
50	3670
50	3750
50	3950
50	4000

# KLÍNOVÉ ŘEMENY Neoprenové klínové řemeny

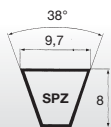

**SP**

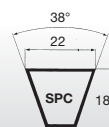
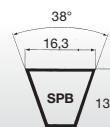

## SEKCE SPZ

Označení	vnější délka (mm)
SPZ 587	600
SPZ 612	625
SPZ 630	643
SPZ 637	650
SPZ 662	675
SPZ 670	683
SPZ 687	700
SPZ 710	723
SPZ 722	735
SPZ 737	750
SPZ 750	763
SPZ 762	775
SPZ 772	785
SPZ 787	800
SPZ 800	813
SPZ 812	825
SPZ 825	838
SPZ 837	850
SPZ 850	863
SPZ 862	875
SPZ 875	888
SPZ 887	900
SPZ 900	913
SPZ 912	925
SPZ 922	935
SPZ 925	938
SPZ 937	950
SPZ 950	963
SPZ 962	975
SPZ 975	988
SPZ 987	1000
SPZ 1000	1013
SPZ 1010	1023
SPZ 1012	1025
SPZ 1024	1037
SPZ 1037	1050
SPZ 1047	1060
SPZ 1060	1073
SPZ 1077	1090
SPZ 1087	1100
SPZ 1112	1125
SPZ 1120	1133
SPZ 1137	1150
SPZ 1140	1153
SPZ 1147	1160
SPZ 1150	1163
SPZ 1162	1175
SPZ 1180	1193
SPZ 1187	1200
SPZ 1200	1213
SPZ 1202	1215
SPZ 1212	1225
SPZ 1237	1250
SPZ 1250	1263
SPZ 1262	1275
SPZ 1270	1283
SPZ 1287	1300
SPZ 1312	1325
SPZ 1320	1333
SPZ 1337	1350
SPZ 1340	1353
SPZ 1347	1360
SPZ 1362	1375
SPZ 1387	1400
SPZ 1400	1413
SPZ 1412	1425
SPZ 1420	1433
SPZ 1437	1450
SPZ 1462	1475
SPZ 1470	1483
SPZ 1487	1500
SPZ 1500	1513
SPZ 1512	1525
SPZ 1520	1533
SPZ 1537	1550
SPZ 1562	1575
SPZ 1587	1600
SPZ 1600	1613
SPZ 1612	1625
SPZ 1637	1650
SPZ 1650	1663
SPZ 1662	1675
SPZ 1687	1700
SPZ 1700	1713
SPZ 1737	1750
SPZ 1750	1763

## SEKCE SPZ

Označení	vnější délka (mm)
SPZ 1762	1775
SPZ 1787	1800
SPZ 1800	1813
SPZ 1812	1825
SPZ 1837	1850
SPZ 1850	1863
SPZ 1862	1875
SPZ 1887	1900
SPZ 1900	1913
SPZ 1937	1950
SPZ 1962	1975
SPZ 1987	2000
SPZ 2000	2013
SPZ 2019	2032
SPZ 2030	2043
SPZ 2037	2050
SPZ 2062	2075
SPZ 2087	2100
SPZ 2120	2133
SPZ 2137	2150
SPZ 2160	2173
SPZ 2187	2200
SPZ 2240	2253
SPZ 2262	2275
SPZ 2287	2300
SPZ 2360	2373
SPZ 2410	2423
SPZ 2437	2450
SPZ 2487	2500
SPZ 2500	2513
SPZ 2540	2553
SPZ 2650	2663
SPZ 2800	2813
SPZ 3000	3013
SPZ 3150	3163
SPZ 3350	3363
SPZ 3550	3563

## SEKCE SPA

Označení	vnější délka (mm)
SPA 657	675
SPA 707	725
SPA 732	750
SPA 757	775
SPA 782	800
SPA 800	818
SPA 807	825
SPA 832	850
SPA 850	868
SPA 857	875
SPA 882	900
SPA 900	918
SPA 907	925
SPA 925	943
SPA 932	950
SPA 950	968
SPA 957	975
SPA 967	985
SPA 982	1000
SPA 1000	1018
SPA 1007	1025
SPA 1032	1050
SPA 1060	1078
SPA 1082	1100
SPA 1107	1125
SPA 1120	1138
SPA 1132	1150
SPA 1150	1168
SPA 1157	1175
SPA 1180	1198
SPA 1207	1225
SPA 1232	1250
SPA 1250	1268
SPA 1257	1275
SPA 1272	1290
SPA 1282	1300
SPA 1307	1325
SPA 1320	1338
SPA 1332	1350
SPA 1357	1375
SPA 1382	1400
SPA 1400	1418
SPA 1407	1425
SPA 1425	1443
SPA 1432	1450
SPA 1450	1468
SPA 1457	1475
SPA 1482	1500
SPA 1500	1518
SPA 1507	1525
SPA 1532	1550
SPA 1550	1568
SPA 1557	1575
SPA 1582	1600
SPA 1600	1618
SPA 1607	1625
SPA 1632	1650
SPA 1657	1675
SPA 1682	1700
SPA 1700	1718
SPA 1707	1725
SPA 1732	1750
SPA 1750	1768
SPA 1757	1775
SPA 1782	1800
SPA 1800	1818
SPA 1807	1825
SPA 1832	1850
SPA 1857	1875
SPA 1882	1900
SPA 1900	1918
SPA 1907	1925
SPA 1925	1943
SPA 1932	1950
SPA 1950	1968
SPA 1957	1975
SPA 1982	2000
SPA 2000	2018
SPA 2032	2050
SPA 2057	2075
SPA 2082	2100
SPA 2120	2138
SPA 2132	2150
SPA 2182	2200
SPA 2207	2225
SPA 2232	2250

## SEKCE SPA

Označení	vnější délka (mm)
SPA 2240	2258
SPA 2282	2300
SPA 2300	2318
SPA 2307	2325
SPA 2332	2350
SPA 2360	2378
SPA 2382	2400
SPA 2432	2450
SPA 2482	2500
SPA 2500	2518
SPA 2532	2550
SPA 2582	2600
SPA 2607	2625
SPA 2632	2650
SPA 2650	2668
SPA 2682	2700
SPA 2732	2750
SPA 2782	2800
SPA 2800	2818
SPA 2832	2850
SPA 2847	2865
SPA 2882	2900
SPA 2900	2918
SPA 2932	2950
SPA 2982	3000
SPA 3000	3018
SPA 3032	3050
SPA 3082	3100
SPA 3150	3168
SPA 3182	3200
SPA 3250	3268
SPA 3282	3300
SPA 3350	3368
SPA 3382	3400
SPA 3550	3568
SPA 3650	3668
SPA 3750	3768
SPA 4000	4018
SPA 4250	4268
SPA 4500	4518
SPA 4750	4768

## SEKCE SPB

Označení	vnější délka (mm)
SPB 1250	1272
SPB 1320	1342
SPB 1400	1422
SPB 1410	1432
SPB 1450	1472
SPB 1500	1522
SPB 1600	1622
SPB 1650	1672
SPB 1700	1722
SPB 1750	1772
SPB 1800	1822
SPB 1850	1872
SPB 1860	1882
SPB 1900	1922
SPB 1950	1972
SPB 2000	2022
SPB 2020	2042
SPB 2060	2082
SPB 2098	2120
SPB 2120	2142
SPB 2150	2172
SPB 2180	2202
SPB 2240	2262
SPB 2264	2286
SPB 2280	2302
SPB 2300	2322
SPB 2360	2382
SPB 2391	2413
SPB 2410	2432
SPB 2430	2452
SPB 2500	2522
SPB 2530	2532
SPB 2580	2602
SPB 2600	2622
SPB 2650	2672
SPB 2680	2702
SPB 2720	2742
SPB 2800	2822
SPB 2840	2862
SPB 2850	2872
SPB 2900	2922
SPB 2950	2972
SPB 3000	3022
SPB 3070	3092
SPB 3150	3172
SPB 3170	3192
SPB 3250	3272
SPB 3320	3342
SPB 3350	3372
SPB 3450	3472
SPB 3550	3572
SPB 3650	3672
SPB 3750	3772
SPB 4000	4022
SPB 4250	4272
SPB 4500	4522
SPB 4750	4772
SPB 5000	5022
SPB 5300	5322
SPB 5600	5622
SPB 6000	6022
SPB 6300	6322
SPB 6700	6722
SPB 7100	7122
SPB 7500	7522
SPB 8000	8022

## SEKCE SPC

Označení	vnější délka (mm)
SPC 2000	2030
SPC 2120	2150
SPC 2240	2270
SPC 2360	2390
SPC 2500	2530
SPC 2650	2680
SPC 2800	2830
SPC 3000	3030
SPC 3150	3180
SPC 3350	3380
SPC 3550	3580
SPC 3750	3780
SPC 4000	4030
SPC 4250	4280
SPC 4500	4530
SPC 4750	4780
SPC 5000	5030
SPC 5300	5330
SPC 5600	5630
SPC 6000	6030
SPC 6300	6330
SPC 6700	6730
SPC 7100	7130
SPC 7500	7530
SPC 8000	8030
SPC 8500	8530
SPC 9000	9030
SPC 9500	9530
SPC 10000	10030
SPC 10600	10630
SPC 11200	11230
SPC 11800	11830
SPC 12000	12030
SPC 12500	12530

**SP**

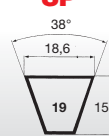

## SEKCE 19

Označení	vrcholová délka (mm)
19	1800
19	1900
19	2000
19	2120
19	2175
19	2240
19	2360
19	2500
19	2650
19	2800
19	3000
19	3150
19	3350
19	3550
19	3750
19	4000
19	4250
19	4500
19	4975
19	5000
19	6275
19	6700
19	9000
19	10000

## KOMPATTEX

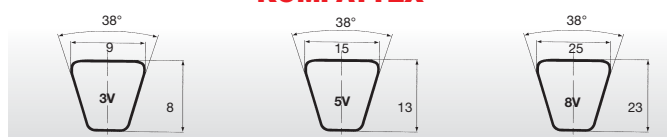

## ESAFLEX

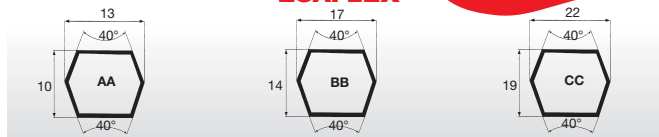

### SEKCE 3V

Označení	vnější délka (mm)
3V 250	635
3V 265	675
3V 280	710
3V 300	760
3V 315	800
3V 335	850
3V 355	900
3V 375	955
3V 400	1015
3V 425	1080
3V 450	1145
3V 475	1205
3V 500	1270
3V 530	1345
3V 560	1420
3V 600	1525
3V 630	1600
3V 670	1700
3V 710	1805
3V 750	1905
3V 800	2030
3V 850	2160
3V 900	2285
3V 950	2415
3V 1000	2540
3V 1060	2690
3V 1120	2845
3V 1180	2995
3V 1250	3175
3V 1320	3355
3V 1400	3555

### SEKCE 5V

Označení	vnější délka (mm)
5V 500	1270
5V 530	1345
5V 560	1420
5V 600	1525
5V 630	1600
5V 670	1700
5V 710	1800
5V 750	1900
5V 800	2030
5V 850	2160
5V 900	2290
5V 950	2410
5V 1000	2540
5V 1060	2690
5V 1120	2840
5V 1180	3000
5V 1250	3180
5V 1320	3350
5V 1400	3550
5V 1500	3810
5V 1600	4060
5V 1700	4320
5V 1800	4570
5V 1900	4830
5V 2000	5080
5V 2120	5380
5V 2240	5690
5V 2360	6000
5V 2500	6350
5V 2650	6730
5V 2800	7100
5V 3000	7620
5V 3150	8000
5V 3350	8500
5V 3550	9000

### SEKCE 8V

Označení	vnější délka (mm)
8V 1000	2540
8V 1060	2690
8V 1120	2840
8V 1180	3000
8V 1250	3180
8V 1320	3350
8V 1400	3550
8V 1500	3810
8V 1600	4060
8V 1700	4320
8V 1800	4570
8V 1900	4830
8V 2000	5080
8V 2120	5380
8V 2240	5690
8V 2360	6000
8V 2500	6350
8V 2650	6730
8V 2800	7100
8V 3000	7620
8V 3150	8000
8V 3350	8500
8V 3550	9000
8V 4000	10160
8V 4250	10800
8V 4500	11430
8V 4750	12060
8V 5000	12700

### SEKCE AA

Označení	účinná délka (mm)
AA 51	1350
AA 60	1580
AA 61	1600
AA 68	1780
AA 69	1805
AA 71	1855
AA 75	1955
AA 77	2010
AA 80	2085
AA 81	2110
AA 85	2210
AA 90	2340
AA 91	2365
AA 95	2465
AA 96	2490
AA 105	2720
AA 108	2800
AA 112	2895
AA 116	3000
AA 120	3100
AA 128	3305

### SEKCE BB

Označení	účinná délka (mm)
BB 50	1345
BB 60	1600
BB 75	1980
BB 81	2130
BB 84	2210
BB 85	2235
BB 90	2360
BB 97	2540
BB 105	2740
BB 112	2920
BB 118	3070
BB 120	3125
BB 121	3150
BB 128	3325
BB 144	3735
BB 154	4000
BB 155	4010
BB 158	4090
BB 173	4470
BB 174	4495
BB 180	4645
BB 184	4750
BB 195	5030
BB 210	5410
BB 240	6135
BB 270	6895
BB 300	7655

### SEKCE CC

Označení	účinná délka (mm)
CC 75	2015
CC 81	2165
CC 85	2265
CC 86	2290
CC 90	2395
CC 96	2545
CC 105	2775
CC 112	2955
CC 120	3155
CC 128	3360
CC 144	3765
CC 153	4000
CC 158	4120
CC 162	4225
CC 173	4500
CC 180	4680
CC 193	5000
CC 195	5060
CC 210	5440
CC 234	6000
CC 240	6155
CC 270	6915
CC 300	7675
CC 313	8000
CC 330	8440
CC 360	9200
CC 390	9965
CC 420	10725

# KLÍNOVÉ ŘEMENY Neoprenové klínové řemeny

## XDV2

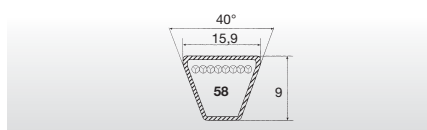
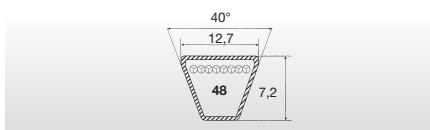
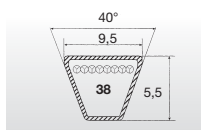

### SEKCE XDV2-38

Označení	vnější délka (mm)
XDV 38/150	381
XDV 38/160	406
XDV 38/170	432
XDV 38/180	457
XDV 38/190	483
XDV 38/200	508
XDV 38/210	533
XDV 38/220	559
XDV 38/230	584
XDV 38/240	610
XDV 38/250	635
XDV 38/260	660
XDV 38/270	686
XDV 38/280	711
XDV 38/290	737
XDV 38/300	762
XDV 38/310	787
XDV 38/320	813
XDV 38/330	838
XDV 38/340	864
XDV 38/350	889
XDV 38/360	914
XDV 38/370	940
XDV 38/380	965
XDV 38/390	991
XDV 38/400	1016
XDV 38/410	1041
XDV 38/420	1067
XDV 38/430	1092
XDV 38/440	1118
XDV 38/450	1143
XDV 38/460	1168
XDV 38/470	1194
XDV 38/480	1219
XDV 38/490	1245
XDV 38/500	1270
XDV 38/510	1295
XDV 38/520	1321
XDV 38/530	1346
XDV 38/540	1372
XDV 38/550	1397
XDV 38/560	1422
XDV 38/570	1448
XDV 38/580	1473
XDV 38/590	1499
XDV 38/600	1524
XDV 38/610	1549
XDV 38/620	1575
XDV 38/630	1600
XDV 38/640	1626
XDV 38/650	1651
XDV 38/660	1676
XDV 38/670	1702
XDV 38/680	1727
XDV 38/690	1753
XDV 38/700	1778
XDV 38/710	1803
XDV 38/720	1829
XDV 38/730	1854
XDV 38/740	1880
XDV 38/750	1905

### SEKCE XDV2-48

Označení	vnější délka (mm)
XDV 48/170	432
XDV 48/180	457
XDV 48/190	483
XDV 48/200	508
XDV 48/210	533
XDV 48/220	559
XDV 48/230	584
XDV 48/240	610
XDV 48/250	635
XDV 48/260	660
XDV 48/270	686
XDV 48/280	711
XDV 48/290	737
XDV 48/300	762
XDV 48/310	787
XDV 48/320	813
XDV 48/330	838
XDV 48/340	864
XDV 48/350	889
XDV 48/360	914
XDV 48/370	940
XDV 48/380	965
XDV 48/390	991
XDV 48/400	1016
XDV 48/410	1041
XDV 48/420	1067
XDV 48/430	1092
XDV 48/440	1118
XDV 48/450	1143
XDV 48/460	1168
XDV 48/470	1194
XDV 48/480	1219
XDV 48/490	1245
XDV 48/500	1270
XDV 48/510	1295
XDV 48/520	1321
XDV 48/530	1346
XDV 48/540	1372
XDV 48/550	1397
XDV 48/560	1422
XDV 48/570	1448
XDV 48/580	1473
XDV 48/590	1499
XDV 48/600	1524
XDV 48/610	1549
XDV 48/620	1575
XDV 48/630	1600
XDV 48/640	1626
XDV 48/650	1651
XDV 48/660	1676
XDV 48/670	1702
XDV 48/680	1727
XDV 48/690	1753
XDV 48/700	1778
XDV 48/710	1803
XDV 48/720	1829
XDV 48/730	1854
XDV 48/740	1880
XDV 48/750	1905
XDV 48/760	1930
XDV 48/770	1956
XDV 48/780	1981
XDV 48/790	2007
XDV 48/800	2032
XDV 48/810	2057
XDV 48/820	2083
XDV 48/830	2108
XDV 48/840	2134
XDV 48/850	2159
XDV 48/860	2184
XDV 48/870	2210
XDV 48/880	2235
XDV 48/890	2261
XDV 48/900	2286
XDV 48/910	2311

### SEKCE XDV2-48

Označení	vnější délka (mm)
XDV 48/920	2337
XDV 48/930	2362
XDV 48/940	2388
XDV 48/950	2413
XDV 48/960	2438
XDV 48/970	2464
XDV 48/980	2489
XDV 48/990	2515
XDV 48/1000	2540
XDV 48/1050	2667
XDV 48/1070	2718
XDV 48/1140	2896
XDV 48/1170	2972

### SEKCE XDV2-58

Označení	vnější délka (mm)
XDV 58/230	584
XDV 58/240	610
XDV 58/250	635
XDV 58/260	660
XDV 58/270	686
XDV 58/280	711
XDV 58/290	737
XDV 58/300	762
XDV 58/310	787
XDV 58/320	813
XDV 58/330	838
XDV 58/340	864
XDV 58/350	889
XDV 58/360	914
XDV 58/370	940
XDV 58/380	965
XDV 58/390	991
XDV 58/400	1016
XDV 58/410	1041
XDV 58/420	1067
XDV 58/430	1092
XDV 58/440	1118
XDV 58/450	1143
XDV 58/460	1168
XDV 58/470	1194
XDV 58/480	1219
XDV 58/490	1245
XDV 58/500	1270
XDV 58/510	1295
XDV 58/520	1321
XDV 58/530	1346
XDV 58/540	1372
XDV 58/550	1397
XDV 58/560	1422
XDV 58/570	1448
XDV 58/580	1473
XDV 58/590	1499
XDV 58/600	1524
XDV 58/610	1549
XDV 58/620	1575
XDV 58/630	1600
XDV 58/640	1626
XDV 58/650	1651
XDV 58/660	1676
XDV 58/670	1702
XDV 58/680	1727
XDV 58/690	1753
XDV 58/700	1778
XDV 58/710	1803
XDV 58/720	1829
XDV 58/730	1854
XDV 58/740	1880
XDV 58/750	1905
XDV 58/760	1930
XDV 58/770	1956
XDV 58/780	1981
XDV 58/790	2007
XDV 58/800	2032
XDV 58/810	2057
XDV 58/820	2083
XDV 58/830	2108
XDV 58/840	2134
XDV 58/850	2159
XDV 58/860	2184
XDV 58/870	2210
XDV 58/880	2235
XDV 58/890	2261
XDV 58/900	2286
XDV 58/910	2311
XDV 58/920	2337
XDV 58/930	2362
XDV 58/940	2388
XDV 58/950	2413
XDV 58/960	2438
XDV 58/970	2464

### SEKCE XDV2-58

Označení	vnější délka (mm)
XDV 58/980	2489
XDV 58/990	2515
XDV 58/1000	2540
XDV 58/1030	2616
XDV 58/1080	2743



## LINEA X

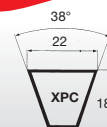
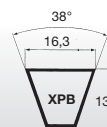
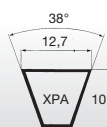
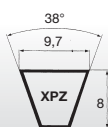

### SEKCE XPZ

Označení	vnější délka (mm)
XPZ 512	525
XPZ 562	575
XPZ 587	600
XPZ 612	625
XPZ 630	643
XPZ 637	650
XPZ 662	675
XPZ 670	683
XPZ 687	700
XPZ 710	723
XPZ 722	735
XPZ 737	750
XPZ 750	763
XPZ 762	775
XPZ 787	800
XPZ 800	813
XPZ 812	825
XPZ 837	850
XPZ 850	863
XPZ 862	875
XPZ 875	888
XPZ 887	900
XPZ 900	913
XPZ 912	925
XPZ 925	938
XPZ 937	950
XPZ 950	963
XPZ 962	975
XPZ 987	1000
XPZ 1000	1013
XPZ 1012	1025
XPZ 1037	1050
XPZ 1047	1060
XPZ 1060	1073
XPZ 1062	1075
XPZ 1077	1090
XPZ 1087	1100
XPZ 1112	1125
XPZ 1120	1133
XPZ 1137	1150
XPZ 1162	1175
XPZ 1180	1193
XPZ 1187	1200
XPZ 1202	1215
XPZ 1212	1225
XPZ 1237	1250
XPZ 1250	1263
XPZ 1262	1275
XPZ 1270	1283
XPZ 1287	1300
XPZ 1312	1325
XPZ 1320	1333
XPZ 1337	1350
XPZ 1362	1375
XPZ 1387	1400
XPZ 1400	1413
XPZ 1412	1425
XPZ 1420	1433
XPZ 1437	1450
XPZ 1462	1475
XPZ 1487	1500
XPZ 1500	1513
XPZ 1512	1525
XPZ 1520	1533
XPZ 1537	1550
XPZ 1587	1600
XPZ 1600	1613
XPZ 1612	1625
XPZ 1662	1675
XPZ 1700	1713
XPZ 1762	1775
XPZ 1800	1813
XPZ 1900	1913
XPZ 2000	2013
XPZ 2030	2043

### SEKCE XPZ

Označení	vnější délka (mm)
XPZ 2120	2133
XPZ 2160	2173
XPZ 2240	2253
XPZ 2280	2293
XPZ 2360	2373
XPZ 2410	2423
XPZ 2500	2513
XPZ 2540	2553
XPZ 2650	2663
XPZ 2690	2703
XPZ 2800	2813
XPZ 2840	2853
XPZ 3000	3013
XPZ 3150	3163
XPZ 3170	3183
XPZ 3350	3363
XPZ 3550	3563

### SEKCE XPA

Označení	vnější délka (mm)
XPA 667	685
XPA 682	700
XPA 732	750
XPA 757	775
XPA 782	800
XPA 800	818
XPA 807	825
XPA 832	850
XPA 850	868
XPA 857	875
XPA 882	900
XPA 900	918
XPA 907	925
XPA 932	950
XPA 950	968
XPA 957	975
XPA 969	987
XPA 982	1000
XPA 1000	1018
XPA 1007	1025
XPA 1032	1050
XPA 1057	1075
XPA 1060	1078
XPA 1082	1100
XPA 1107	1125
XPA 1120	1138
XPA 1132	1150
XPA 1150	1168
XPA 1157	1175
XPA 1180	1198
XPA 1182	1200
XPA 1207	1225
XPA 1232	1250
XPA 1250	1268
XPA 1257	1275
XPA 1272	1290
XPA 1282	1300
XPA 1307	1325
XPA 1320	1338
XPA 1332	1350
XPA 1357	1375
XPA 1382	1400
XPA 1400	1418
XPA 1407	1425
XPA 1420	1438
XPA 1432	1450
XPA 1457	1475
XPA 1482	1500
XPA 1500	1518
XPA 1507	1525
XPA 1532	1550
XPA 1557	1575
XPA 1582	1600
XPA 1600	1618
XPA 1607	1625
XPA 1632	1650
XPA 1650	1668
XPA 1682	1700
XPA 1700	1718
XPA 1732	1750
XPA 1757	1775
XPA 1782	1800
XPA 1800	1818
XPA 1832	1850
XPA 1850	1868
XPA 1900	1918
XPA 1932	1950
XPA 1957	1975
XPA 1982	2000
XPA 2000	2018
XPA 2032	2050
XPA 2057	2075
XPA 2082	2100
XPA 2120	2138
XPA 2160	2178

### SEKCE XPA

Označení	vnější délka (mm)
XPA 2182	2200
XPA 2240	2258
XPA 2282	2300
XPA 2300	2318
XPA 2360	2378
XPA 2432	2450
XPA 2482	2500
XPA 2500	2518
XPA 2532	2550
XPA 2582	2600
XPA 2607	2625
XPA 2632	2650
XPA 2650	2668
XPA 2682	2700
XPA 2732	2750
XPA 2782	2800
XPA 2800	2818
XPA 3000	3018
XPA 3150	3168
XPA 3350	3368
XPA 3550	3568
XPA 3750	3768
XPA 4000	4018
XPA 4250	4268
XPA 4500	4518

### SEKCE XPB

Označení	vnější délka (mm)
XPB 1250	1272
XPB 1260	1282
XPB 1320	1342
XPB 1340	1362
XPB 1400	1422
XPB 1410	1432
XPB 1500	1522
XPB 1510	1532
XPB 1590	1612
XPB 1600	1622
XPB 1650	1672
XPB 1690	1712
XPB 1700	1722
XPB 1800	1822
XPB 1900	1922
XPB 2000	2022
XPB 2020	2042
XPB 2120	2142
XPB 2150	2172
XPB 2240	2262
XPB 2280	2302
XPB 2360	2382
XPB 2410	2432
XPB 2500	2522
XPB 2530	2552
XPB 2650	2672
XPB 2680	2702
XPB 2800	2822
XPB 2840	2862
XPB 2900	2922
XPB 2990	3012
XPB 3000	3022
XPB 3150	3172
XPB 3170	3192
XPB 3340	3362
XPB 3350	3372
XPB 3550	3572
XPB 3750	3772
XPB 3800	3822
XPB 4000	4022
XPB 4060	4082
XPB 4250	4272
XPB 4500	4522
XPB 4750	4772
XPB 5000	5022

### SEKCE XPC

Označení	vnější délka (mm)
XPC 2000	2030
XPC 2120	2150
XPC 2240	2270
XPC 2360	2390
XPC 2500	2530
XPC 2650	2680
XPC 2800	2830
XPC 3000	3030
XPC 3150	3180
XPC 3350	3380
XPC 3550	3580
XPC 3750	3780
XPC 4000	4030
XPC 4250	4280
XPC 4500	4530
XPC 4750	4780
XPC 5000	5030

# KLÍNOVÉ ŘEMENY Neoprenové klínové řemeny

## GOLD LABEL COG-BELT®

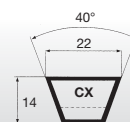
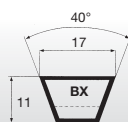
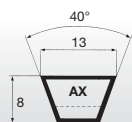

### SEKCE AX

Označení	vnější délka (mm)
AX 21	585
AX 22	610
AX 23	635
AX 24	665
AX 25	690
AX 26	710
AX 27	750
AX 28	765
AX 29	800
AX 30	815
AX 31	850
AX 32	865
AX 33	900
AX 34	915
AX 35	950
AX 36	965
AX 37	1000
AX 38	1020
AX 39	1045
AX 40	1075
AX 41	1095
AX 42	1120
AX 43	1150
AX 44	1170
AX 45	1195
AX 46	1230
AX 47	1245
AX 48	1270
AX 49	1300
AX 50	1325
AX 51	1350
AX 52	1375
AX 53	1400
AX 54	1425
AX 55	1450
AX 56	1475
AX 57	1500
AX 58	1525
AX 59	1550
AX 60	1585
AX 61	1600
AX 62	1630
AX 63	1655
AX 64	1680
AX 65	1710
AX 66	1730
AX 67	1760
AX 68	1790
AX 69	1810
AX 70	1830
AX 71	1865
AX 72	1890
AX 73	1905
AX 74	1935
AX 75	1965
AX 76	1985
AX 77	2010
AX 78	2030
AX 79	2060
AX 80	2080
AX 81	2120
AX 82	2140
AX 83	2160
AX 84	2190
AX 85	2220
AX 86	2240
AX 87	2260
AX 88	2290
AX 89	2310
AX 90	2350
AX 91	2360
AX 92	2390
AX 93	2420
AX 94	2440
AX 95	2470
AX 96	2500
AX 97	2520
AX 98	2540
AX 100	2600
AX 103	2670
AX 105	2730
AX 110	2850
AX 112	2910
AX 120	3110
AX 128	3310
AX 136	3510

### SEKCE AX

Označení	vnější délka (mm)
AX 144	3710
AX 158	4070
AX 173	4450
AX 180	4620

### SEKCE BX

Označení	vnější délka (mm)
BX 28	785
BX 30	835
BX 32	885
BX 34	935
BX 35	960
BX 36	990
BX 38	1040
BX 40	1090
BX 41	1120
BX 42	1140
BX 43	1165
BX 44	1190
BX 45	1215
BX 46	1250
BX 47	1265
BX 48	1295
BX 49	1320
BX 50	1345
BX 51	1370
BX 52	1400
BX 53	1420
BX 54	1445
BX 55	1470
BX 56	1500
BX 57	1520
BX 58	1545
BX 59	1570
BX 60	1600
BX 61	1625
BX 62	1650
BX 63	1675
BX 64	1700
BX 65	1725
BX 66	1750
BX 67	1775
BX 68	1800
BX 69	1825
BX 70	1850
BX 71	1875
BX 72	1900
BX 73	1930
BX 74	1955
BX 75	1980
BX 76	2000
BX 77	2030
BX 78	2050
BX 79	2080
BX 80	2110
BX 81	2130
BX 82	2160
BX 83	2180
BX 84	2210
BX 85	2240
BX 86	2260
BX 87	2280
BX 88	2310
BX 89	2330
BX 90	2360
BX 91	2390
BX 92	2410
BX 93	2440
BX 94	2460
BX 95	2500
BX 96	2510
BX 97	2540
BX 98	2560
BX 99	2590
BX 100	2620
BX 103	2690
BX 105	2740
BX 106	2770
BX 108	2820
BX 112	2920
BX 113	2940
BX 115	2990
BX 116	3020
BX 120	3130
BX 123	3200
BX 124	3220
BX 126	3270
BX 128	3330
BX 133	3450
BX 136	3530
BX 140	3630
BX 144	3740
BX 148	3830

### SEKCE BX

Označení	vnější délka (mm)
BX 150	3880
BX 154	3990
BX 158	4090
BX 162	4200
BX 173	4480
BX 180	4650
BX 191	4930
BX 195	5040

### SEKCE CX

Označení	vnější délka (mm)
CX 51	1400
CX 55	1500
CX 60	1630
CX 68	1830
CX 72	1935
CX 75	2000
CX 78	2090
CX 81	2160
CX 85	2270
CX 90	2390
CX 96	2540
CX 100	2650
CX 101	2670
CX 105	2770
CX 109	2870
CX 111	2920
CX 112	2950
CX 115	3030
CX 120	3150
CX 128	3350
CX 136	3550
CX 144	3760
CX 148	3860
CX 150	3920
CX 158	4120
CX 162	4220
CX 173	4500
CX 180	4680

## KOMPATTEX COG-BELT

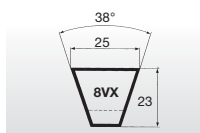
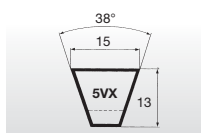
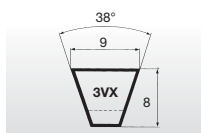

### SEKCE 3VX

Označení	vnější délka (mm)
3VX 250	630
3VX 265	670
3VX 280	710
3VX 300	760
3VX 315	800
3VX 335	850
3VX 355	900
3VX 375	950
3VX 400	1015
3VX 425	1080
3VX 450	1145
3VX 475	1205
3VX 500	1270
3VX 530	1345
3VX 560	1420
3VX 600	1525
3VX 630	1600
3VX 670	1700
3VX 710	1800
3VX 750	1900
3VX 800	2030
3VX 850	2160
3VX 900	2290
3VX 950	2410
3VX 1000	2540
3VX 1060	2690
3VX 1120	2840
3VX 1180	3000
3VX 1250	3180
3VX 1320	3350
3VX 1400	3550
3VX 1500	3810

### SEKCE 5VX

Označení	vnější délka (mm)
5VX 450	1150
5VX 470	1190
5VX 490	1250
5VX 500	1270
5VX 510	1290
5VX 530	1345
5VX 540	1370
5VX 550	1400
5VX 560	1420
5VX 570	1450
5VX 580	1470
5VX 590	1500
5VX 600	1525
5VX 610	1550
5VX 630	1600
5VX 650	1650
5VX 660	1680
5VX 670	1700
5VX 680	1730
5VX 690	1750
5VX 710	1800
5VX 730	1850
5VX 740	1880
5VX 750	1900
5VX 780	1980
5VX 800	2030
5VX 810	2060
5VX 830	2110
5VX 840	2130
5VX 850	2160
5VX 860	2180
5VX 880	2240
5VX 900	2290
5VX 930	2360
5VX 950	2410
5VX 960	2440
5VX 1000	2540
5VX 1030	2620
5VX 1060	2690
5VX 1080	2740
5VX 1120	2840
5VX 1150	2920
5VX 1160	2950
5VX 1180	3000
5VX 1230	3130
5VX 1250	3180
5VX 1320	3350
5VX 1400	3550
5VX 1500	3810
5VX 1600	4060
5VX 1700	4320
5VX 1800	4570
5VX 1900	4830
5VX 2000	5080

### SEKCE 8VX

Označení	vnější délka (mm)
8VX 1000	2540
8VX 1060	2690
8VX 1120	2840
8VX 1180	3000
8VX 1250	3180
8VX 1320	3350
8VX 1400	3550
8VX 1500	3810
8VX 1600	4060
8VX 1700	4320
8VX 1800	4570
8VX 1900	4830
8VX 2000	5080



# KLÍNOVÉ ŘEMENY Neoprenové klínové řemeny

## VARISECT

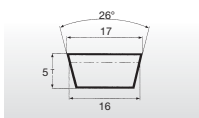

### SEKCE 17x5

Označení	vrcholová délka (mm)
W 16P	450
W 16P	500
W 16P	560
W 16P	600
W 16P	630
W 16P	710
W 16P	800
W 16P	900
W 16P	1000

## VARISECT

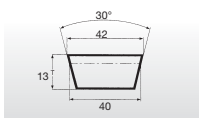

### SEKCE 42x13

Označení	vrcholová délka (mm)
W 40P	1060
W 40P	1100
W 40P	1120
W 40P	1180
W 40P	1250
W 40P	1400
W 40P	1600
W 40P	1660
W 40P	1800
W 40P	2000
W 40P	2240
W 40P	2500

## VARISECT

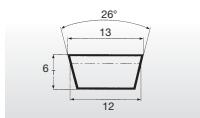

### SEKCE 13x6

vnitřní délka (mm)	vrcholová délka (mm)
425	455
500	530
525	555
550	580
650	680
675	705
700	730
725	755
750	780
775	805
900	930

## VARISECT

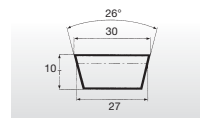

### SEKCE 30x10

vnitřní délka (mm)	vrcholová délka (mm)
650	700
665	715
700	750
800	850
850	900
875	925
900	950
950	1000
1000	1050
1035	1085
1050	1100
1120	1170
1200	1250
1320	1370
1340	1390
1500	1550
1600	1650

## VARISECT

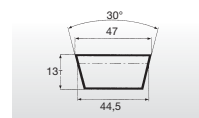

### SEKCE 47x13

vnitřní délka (mm)	vrcholová délka (mm)
900	1000
950	1010
1000	1060
1060	1120
1120	1180
1180	1240
1250	1310
1320	1380
1400	1460
1500	1560
1600	1660
1700	1760
1800	1860
1900	1960
2000	2060
2240	2300

## VARISECT

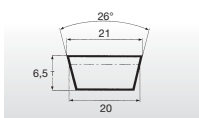

### SEKCE 21x6,5

Označení	vrcholová délka (mm)
W 20P	560
W 20P	630
W 20P	640
W 20P	710
W 20P	800
W 20P	900
W 20P	1000
W 20P	1120
W 20P	1250

## VARISECT

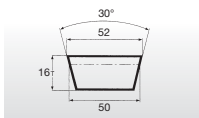

### SEKCE 52x16

Označení	vrcholová délka (mm)
W 50P	1250
W 50P	1400
W 50P	1600
W 50P	1800
W 50P	2000
W 50P	2240
W 50P	2500
W 50P	2800
W 50P	3150

## VARISECT

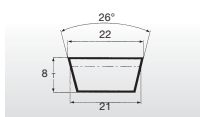

### SEKCE 22x8

vnitřní délka (mm)	vrcholová délka (mm)
500	540
525	565
550	590
575	615
600	640
610	650
625	665
650	690
675	715
700	740
725	765
750	790
800	840
850	890
900	940
950	990
1000	1040
1060	1100
1120	1160
1180	1220
1250	1290
1320	1360
1400	1440
1500	1540
1600	1640
2000	2040

## VARISECT

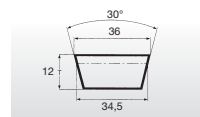

### SEKCE 36x12

vnitřní délka (mm)	vrcholová délka (mm)
700	755
725	780
800	855
850	905
900	955
950	1005
1000	1055
1060	1115
1120	1175
1180	1235
1250	1305
1320	1375
1400	1455
1500	1555
1600	1655
1700	1755
1800	1855
2000	2055
2120	2175

## VARISECT

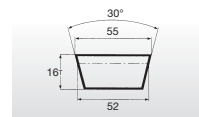

### SEKCE 55x16

vnitřní délka (mm)	vrcholová délka (mm)
1180	1255
1250	1325
1400	1475
1600	1675
1700	1775
1800	1875
2000	2075
2240	2315

## VARISECT

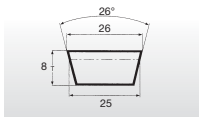

### SEKCE 26x8

Označení	vrcholová délka (mm)
W 25P	560
W 25P	690
W 25P	710
W 25P	750
W 25P	790
W 25P	800
W 25P	900
W 25P	1000
W 25P	1120
W 25P	1250
W 25P	1400
W 25P	1600

## VARISECT

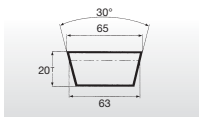

### SEKCE 65x20

Označení	vnitřní délka (mm)
W 63P	1600
W 63P	1800
W 63P	2000
W 63P	2240
W 63P	2500
W 63P	2800
W 63P	3150
W 63P	3550
W 63P	4000

## VARISECT

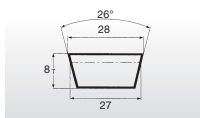

### SEKCE 28x8

vnitřní délka (mm)	vrcholová délka (mm)
525	565
600	640
625	665
650	690
700	740
750	790
800	840
850	890
900	940
950	990
1000	1040
1060	1100
1120	1160
1180	1220
1250	1290
1320	1360
1400	1440
1500	1540
1600	1640
1700	1740

## VARISECT

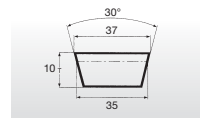

### SEKCE 37x10

vnitřní délka (mm)	vrcholová délka (mm)
600	650
650	700
675	725
750	800
800	850
850	900
900	950
950	1000
1000	1050
1060	1110
1120	1170
1180	1230
1250	1300
1320	1370
1400	1450
1500	1550
1600	1650
1700	1750
1800	1850
1900	1950
2000	2050
2240	2290

## VARISECT

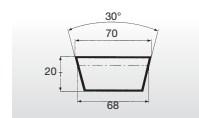

### SEKCE 70x20

vnitřní délka (mm)	vrcholová délka (mm)
1320	1415
1400	1495
1445	1540
1500	1595
1600	1695
1700	1795
1800	1895
1900	1995
2000	2095
2120	2210
2240	2330
2360	2450
2500	2590
2800	2890

## VARISECT

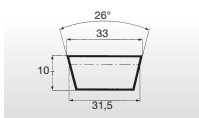

### SEKCE 33x10

Označení	vrcholová délka (mm)
W 31,5P	800
W 31,5P	840
W 31,5P	870
W 31,5P	900
W 31,5P	950
W 31,5P	1000
W 31,5P	1050
W 31,5P	1120
W 31,5P	1250
W 31,5P	1400
W 31,5P	1600
W 31,5P	1800
W 31,5P	2000



## PLURIBAND®

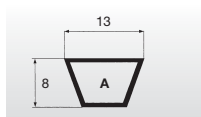

### SEKCE A

Označení	vnitřní délka (mm)
A 47	1200
A 51	1300
A 56	1422
A 57	1450
A 59	1500
A 64	1625
A 67	1700
A 71	1800
A 75	1900
A 79	2000
A 88	2240
A 98	2500
A 100	2540
A 104	2650
A 112	2845
A 120	3048
A 128	3250
A 144	3658
A 158	4000
A 167	4250
A 187	4750

### PLURIBAND®

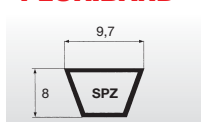

### SEKCE SPZ

Označení	vnější délka (mm)
SPZ 1250	1250
SPZ 1400	1400
SPZ 1500	1500
SPZ 1600	1600
SPZ 1700	1700
SPZ 1800	1800
SPZ 1900	1900
SPZ 2000	2000
SPZ 2120	2120
SPZ 2240	2240
SPZ 2360	2360
SPZ 2500	2500
SPZ 2650	2650
SPZ 2800	2800
SPZ 3000	3000
SPZ 3150	3150
SPZ 3350	3350
SPZ 3550	3550

### PLURIBAND®



### SEKCE SPA

Označení	vnitřní délka (mm)
SPA 1250	1250
SPA 1400	1400
SPA 1500	1500
SPA 1600	1600
SPA 1700	1700
SPA 1800	1800
SPA 1900	1900
SPA 2000	2000
SPA 2120	2120
SPA 2240	2240
SPA 2360	2360
SPA 2500	2500
SPA 2650	2650
SPA 2800	2800
SPA 3000	3000
SPA 3150	3150
SPA 3350	3350
SPA 3550	3550
SPA 3750	3750
SPA 4000	4000
SPA 4250	4250
SPA 4500	4500

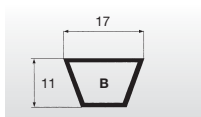

### SEKCE B

Označení	vnitřní délka (mm)
B 70	1778
B 71	1803
B 72	1829
B 73	1854
B 74	1880
B 75	1905
B 76	1930
B 78	1981
B 79	2007
B 80	2032
B 81	2057
B 82	2083
B 83	2108
B 84	2134
B 85	2159
B 86	2184
B 87	2210
B 88	2235
B 89	2261
B 90	2286
B 91	2311
B 92	2337
B 93	2362
B 94	2388
B 95	2413
B 96	2438
B 97	2464
B 98	2489
B 99	2515
B 100	2540
B 102	2591
B 104	2642
B 105	2667
B 106	2692
B 107	2718
B 108	2743
B 110	2794
B 112	2845
B 114	2896
B 115	2921
B 116	2946
B 118	2997
B 120	3048
B 124	3150
B 127	3226
B 128	3251
B 130	3302
B 131	3327
B 132	3353
B 133	3378
B 134	3404
B 135	3429
B 136	3454
B 140	3556
B 144	3658
B 147	3734
B 148	3759
B 151	3835
B 152	3861
B 154	3912
B 157	3988
B 158	4013
B 161	4089
B 162	4115
B 163	4140
B 165	4191
B 167	4242
B 168	4267
B 173	4394
B 175	4445
B 177	4496
B 180	4572
B 186	4724
B 188	4775
B 192	4877
B 195	4953
B 197	5004

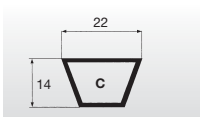

### SEKCE C

Označení	vnitřní délka (mm)
C 98	2489
C 99	2515
C 100	2540
C 101	2565
C 102	2591
C 104	2642
C 105	2667
C 106	2692
C 108	2743
C 110	2794
C 112	2845
C 115	2921
C 118	2997
C 120	3048
C 124	3150
C 128	3251
C 130	3302
C 134	3404
C 136	3454
C 140	3556
C 142	3607
C 144	3658
C 148	3759
C 153	3886
C 158	4013
C 160	4064
C 165	4191
C 166	4216
C 168	4267
C 173	4394
C 180	4572
C 195	4953

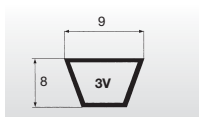

### SEKCE 3V

Označení	vnější délka (mm)
3V 335	850
3V 355	900
3V 375	950
3V 400	1015
3V 425	1080
3V 450	1145
3V 475	1205
3V 500	1270
3V 530	1345
3V 560	1420
3V 600	1525
3V 630	1600
3V 670	1700
3V 710	1800
3V 750	1900
3V 800	2030
3V 850	2160
3V 900	2290
3V 950	2410
3V 1000	2540
3V 1060	2690
3V 1120	2840
3V 1180	3000
3V 1250	3180
3V 1320	3350
3V 1400	3550

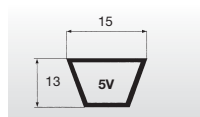

### SEKCE 5V

Označení	vnější délka (mm)
5V 500	1270
5V 530	1345
5V 560	1420
5V 600	1525
5V 630	1600
5V 670	1700
5V 710	1800
5V 750	1900
5V 800	2030
5V 850	2160
5V 900	2290
5V 950	2410
5V 1000	2540
5V 1120	2840
5V 1180	3000
5V 1250	3180
5V 1320	3350
5V 1400	3550
5V 1500	3810
5V 1600	4060
5V 1700	4320
5V 1800	4570
5V 1900	4830
5V 2000	5080
5V 2120	5380
5V 2240	5690
5V 2360	6000
5V 2500	6350
5V 2650	6730
5V 2800	7100
5V 3000	7620
5V 3150	8000
5V 3350	8500
5V 3550	9000

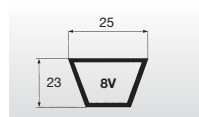

### SEKCE 8V

Označení	vnější délka (mm)
8V 1000	2540
8V 1060	2690
8V 1120	2840
8V 1180	3000
8V 1250	3180
8V 1320	3350
8V 1400	3550
8V 1500	3810
8V 1600	4060
8V 1700	4320
8V 1800	4570
8V 1900	4830
8V 2000	5080
8V 2120	5380
8V 2240	5690
8V 2360	6000
8V 2500	6350
8V 2650	6730
8V 2800	7100
8V 3000	7620
8V 3150	8000
8V 3350	8500
8V 3550	9000
8V 3750	9500
8V 4000	10160
8V 4250	10800
8V 4500	11430
8V 4750	12060
8V 5000	12700
8V 5600	14200
8V 6000	15250

### PLURIBAND®

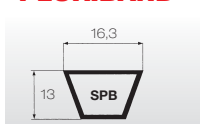

### SEKCE SPB

Označení	vnitřní délka (mm)
SPB 2000	2000
SPB 2120	2120
SPB 2240	2240
SPB 2360	2360
SPB 2500	2500
SPB 2650	2650
SPB 2800	2800
SPB 3000	3000
SPB 3150	3150
SPB 3350	3350
SPB 3550	3550
SPB 3750	3750
SPB 4000	4000
SPB 4250	4250
SPB 4500	4500
SPB 4750	4750
SPB 5000	5000
SPB 5300	5300
SPB 5600	5600
SPB 6000	6000
SPB 6300	6300
SPB 6700	6700
SPB 7100	7100
SPB 7500	7500
SPB 8000	8000

### PLURIBAND®

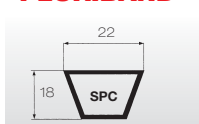

### SEKCE SPC

Označení	vnitřní délka (mm)
SPC 3000	3000
SPC 3150	3150
SPC 3350	3350
SPC 3550	3550
SPC 3750	3750
SPC 4000	4000
SPC 4250	4250
SPC 4500	4500
SPC 4750	4750
SPC 5000	5000
SPC 5300	5300
SPC 5600	5600
SPC 6000	6000
SPC 6300	6300
SPC 6700	6700
SPC 7100	7100
SPC 7500	7500
SPC 8000	8000
SPC 8500	8500
SPC 9000	9000
SPC 9500	9500
SPC 10000	10000
SPC 10600	10600
SPC 11200	11200

### PLURIBAND®

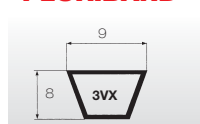

### SEKCE 3VX

Označení	vnější délka (mm)
3VX 250	630
3VX 265	670
3VX 280	710
3VX 300	760
3VX 315	800
3VX 335	850
3VX 355	900
3VX 375	950
3VX 400	1015
3VX 425	1080
3VX 450	1145
3VX 475	1205
3VX 500	1270
3VX 530	1345
3VX 560	1420
3VX 600	1525
3VX 630	1600
3VX 670	1700
3VX 710	1800
3VX 750	1900
3VX 800	2030
3VX 850	2160
3VX 900	2290
3VX 950	2410
3VX 1000	2540
3VX 1060	2690
3VX 1120	2840
3VX 1180	3000
3VX 1250	3180
3VX 1320	3350
3VX 1400	3550

### PLURIBAND®

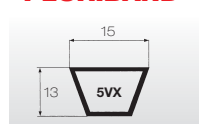

### SEKCE 5VX

Označení	vnější délka (mm)
5VX 500	1270
5VX 530	1345
5VX 560	1420
5VX 600	1525
5VX 630	1600
5VX 670	1700
5VX 710	1800
5VX 800	2030
5VX 850	2160
5VX 900	2290
5VX 950	2410
5VX 1000	2540
5VX 1060	2690
5VX 1120	2840
5VX 1180	3000
5VX 1250	3180
5VX 1320	3350
5VX 1400	3550
5VX 1500	3810
5VX 1600	4060
5VX 1700	4320
5VX 1800	4570
5VX 1900	4830
5VX 2000	5080

# POLY-V DRÁŽKOVÉ ŘEMENY

Neoprenové drážkové řemeny





**POLY-V DRÁŽKOVÉ ŘEMENY** se vyrábějí z polybutadienových komponent. Jsou určeny k přenosu vyšších výkonů a vyrábějí se v profilech **H, J, L a M** (K na poptávku).

Poly-V řemeny:

- eliminují sadování řemenů
- umožňují vytvoření převodu požadované síly nebo převodu s úsporou místa
- rozkládají zatížení převodu rovnoměrně do celé šíře řemene
- umožňují klidný chod a vysoký hnací efekt
- Poly-V jsou velmi vhodné pro malé průměry řemenic a vysoké otáčky

PV drážkové řemeny se dodávají také v elastickém provedení (TEM) a jsou vhodné pro ty převody, kde je požadována pevná osová vzdálenost. TEM řemeny se vyrábějí dle konkrétních požadavků zákazníků.

Kromě rozměrů uvedených v tabulkách se vyrábějí a dodávají různé další typy a rozměry řemenů Poly-V pro použití zejména v domácích elektrospotřebičích. Tyto řemeny Vám dodáme na základě Vaší poptávky.

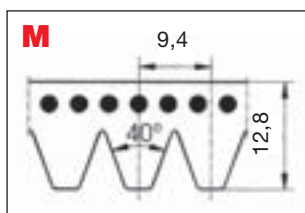
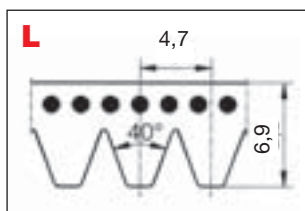
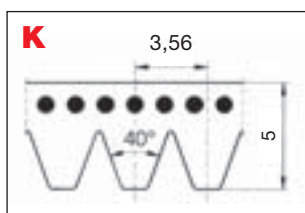
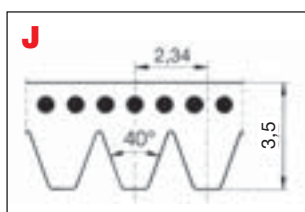
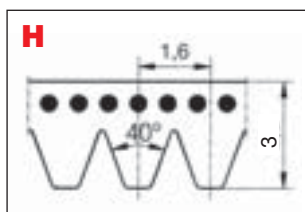

<b>J</b>		<b>J</b>		<b>K</b>		<b>L</b>	<b>M</b>
účinná délka		účinná délka		účinná délka		účinná délka	účinná délka
(mm)	(palce)	(mm)	(palce)	(mm)	(palce)	(palce)	(mm)
350	13.8	1236	48.7	630	24.8	37.5	900
381	15.0	1244	49.0	650	25.6	39.0	940
406	16.0	1262	49.7	675	26.6	42.3	990
432	17.0	1270	50.0	700	27.6	42.5	1060
457	18.0	1280	50.4	730	28.7	47.0	1115
483	19.0	1287	50.7	755	29.7	50.0	1150
495	19.5	1295	51.0	775	30.5	52.0	1185
508	20.0	1302	51.3	800	31.5	52.5	1230
533	21.0	1315	51.8	830	32.7	54.0	1310
559	22.0	1318	51.9	845	33.3	55.0	1390
584	23.0	1321	52.0	870	34.3	56.0	1470
610	24.0	1326	52.2	885	34.8	56.5	1610
650	25.6	1365	53.7	925	36.4	58.0	1650
660	26.0	1371	54.0	950	37.4	61.5	1760
685	27.0	1397	55.0	970	38.2	63.5	1830
711	28.0	1428	56.2	1000	39.4	65.5	1980
723	28.5	1473	58.0	1015	40.0	67.5	2130
737	29.0	1524	60.0	1035	40.8	69.5	2410
762	30.0	1549	61.0	1060	41.7	71.0	2710
769	30.3	1651	65.0	1080	42.5	72.5	3010
790	31.1	1752	69.0	1145	45.1	76.5	3310
813	32.0	1854	73.0	1165	45.9	77.0	3610
864	34.0	1895	74.6	1200	47.2	78.0	3910
895	35.2	1910	75.2	1230	48.4	79.5	4210
914	36.0	1930	76.0	1300	51.2	81.5	4810
944	37.2	1956	77.0	1335	52.6	82.5	5410
955	37.6	2083	82.0	1385	54.5	84.0	6010
965	38.0	2135	84.1	1420	55.9	86.5	6600
990	39.0	2210	87.0	1460	57.5	88.0	
1016	40.0	2337	92.0	1490	58.7	91.5	
1036	40.8	2489	98.0	1520	59.8	93.0	
1040	40.9			1555	61.2	97.5	
1051	41.4			1610	63.4	99.0	
1065	41.9			1655	65.2	106.5	
1080	42.5			1700	66.9	108.0	
1089	42.9			1725	67.9	112.0	
1092	43.0			1755	69.1	114.0	
1100	43.3			1800	70.9	115.0	
1108	43.6			1860	73.2	118.0	
1116	43.9			1885	74.2	121.5	
1136	44.7			1900	74.8	123.0	
1143	45.0			1980	78.0	129.5	
1150	45.3			2050	80.7	131.0	
1160	45.7			2080	81.9	137.5	
1168	46.0			2145	84.5	145.5	
1170	46.1			2235	88.0	159.5	
1184	46.6			2330	91.7	165.0	
1190	46.9			2490	98.03	176.0	
1194	47.0			2555	100.59	182.0	
1200	47.2					198.0	
1203	47.4					212.0	
1210	47.6					240.0	
1214	47.8						
1222	48.1						
1232	48.5						

<b>H</b>
účinná délka
(mm)
594
1200
1210
1265
1578
1830
1869
1885
1900
1904
1915
1922
1930
1940
1945
1975







**MEGADYNE GUMOVÉ OZUBENÉ ŘEMENY** se dodávají buď s jednostranným nebo oboustranným ozubením, s klasickými nebo RPP profily. Výroba probíhá s využitím nejmodernějších technologií.

#### **ISORAN® KLASICKÉ SYNCHRONNÍ ŘEMENY MXL XL L H XH XXH**

- lichoběžníkový tvar ozubení
- polychloroprenové komponenty pro ideální záběr zubů
- použité skelné vlákno pro eliminaci vytahování
- textilní tkanina chránící poškození ozubení

#### **ISORAN® RPP3 RPP5 RPP8 RPP14 RPP20**

- RPP parabolický tvar umožňuje zvýšení kalibrovaného tlaku ve vrcholku zubu
- vystužení skelným vláknem pro eliminaci prodloužení a vysokou flexibilitu
- chloroprenové komponenty pro zvýšení odolnosti vůči oděru a prodloužení životnosti
- textilní tkanina pro ochranu ozubení se samomazným efektem



**Nové synchronní řemeny RPP SILVER a RPP GOLD** jsou konstrukčně navrženy z velmi kvalitních materiálů. Sloučením pevností všech použitých materiálů garantují mimořádnou kapacitu kroutícího momentu. ISORAN RPP SILVER umožňuje zvýšit kapacitu zatížení o 10% ve srovnání s předchozím typem RPP PLUS. ISORAN RPP GOLD dokonce o více než 30% proti původnímu RPP PANTHER.

ISORAN RPP SILVER a RPP GOLD a jejich přednosti:

- zvýšení výkonu existujících převodů bez nutnosti výměny řemenic
- dokonalá zaměnitelnost parabolického a HTD tvaru u řemenic
- antistatické provedení dle norem BS 2005
- hnací účinnost až do 98%
- vhodné pro napínání seshora
- vyšší odolnost vůči přeskokování zubů
- vyšší odolnost proti poškození ozubení stříhem
- tichý, bezúdržbový provoz

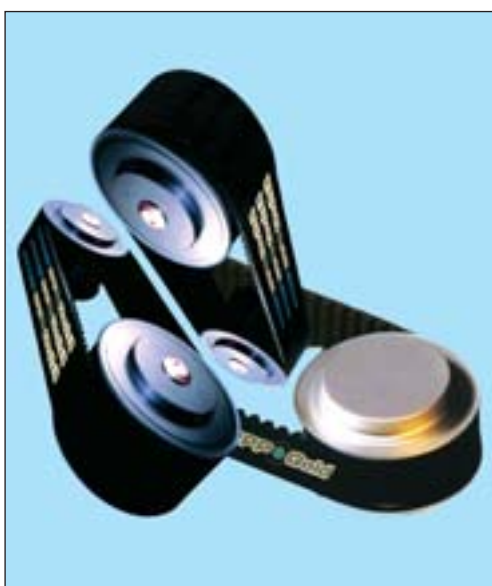

ISORAN RPP SILVER se vyrábějí v roztečích 5 mm, 8 mm a 14 mm. RPP GOLD se vyrábí v roztečích 8 mm a 14 mm (na požádání 5 mm).

RPP® 5 SILVER DD, RPP® 8 SILVER DD a RPP® 14 SILVER DD je možné vyrobit na poptávku.

Dostupnost RPP® GOLD DD: pouze na poptávku.

**RPP3 - RPP5 - RPP8 - RPP14**  
**RPP20 - RPP5 SILVER**  
**RPP8 SILVER - RPP14 SILVER**  
**RPP8 GOLD - RPP14 GOLD**

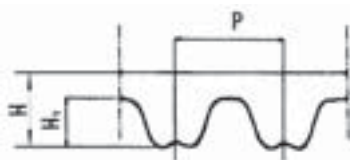

<b>RPP3</b>	
Označení	vrcholová délka (mm)
90 RPP3	90
105 RPP3	105
129 RPP3	129
141 RPP3	141
144 RPP3	144
147 RPP3	147
150 RPP3	150
156 RPP3	156
159 RPP3	159
168 RPP3	168
174 RPP3	174
177 RPP3	177
180 RPP3	180
186 RPP3	186
195 RPP3	195
201 RPP3	201
204 RPP3	204
210 RPP3	210
213 RPP3	213
225 RPP3	225
231 RPP3	231
240 RPP3	240
243 RPP3	243
246 RPP3	246
249 RPP3	249
252 RPP3	252
255 RPP3	255
261 RPP3	261
264 RPP3	264
267 RPP3	267
270 RPP3	270
276 RPP3	276
285 RPP3	285
288 RPP3	288
291 RPP3	291
297 RPP3	297
300 RPP3	300
312 RPP3	312
318 RPP3	318
327 RPP3	327
330 RPP3	330
333 RPP3	333
336 RPP3	336
339 RPP3	339
345 RPP3	345
357 RPP3	357
363 RPP3	363
375 RPP3	375
384 RPP3	384
390 RPP3	390
393 RPP3	393
405 RPP3	405
420 RPP3	420
432 RPP3	432
447 RPP3	447
474 RPP3	474
480 RPP3	480
486 RPP3	486
489 RPP3	489
501 RPP3	501
510 RPP3	510
513 RPP3	513
522 RPP3	522
531 RPP3	531
537 RPP3	537
564 RPP3	564
570 RPP3	570
576 RPP3	576
579 RPP3	579
597 RPP3	597
600 RPP3	600
633 RPP3	633
648 RPP3	648
669 RPP3	669
711 RPP3	711
735 RPP3	735
738 RPP3	738
756 RPP3	756
804 RPP3	804
882 RPP3	882
945 RPP3	945
1062 RPP3	1062

<b>RPP3</b>	
Označení	vrcholová délka (mm)
1125 RPP3	1125
1245 RPP3	1245
1263 RPP3	1263
1500 RPP3	1500
1530 RPP3	1530
1863 RPP3	1863
P 3	
H <sub>1</sub>	1,15
H	2,4

<b>RPP5</b>	
Označení	vrcholová délka (mm)
180 RPP5	180
225 RPP5	225
235 RPP5	235
245 RPP5	245
255 RPP5	255
265 RPP5	265
270 RPP5	270
280 RPP5	280
285 RPP5	285
295 RPP5	295
300 RPP5	300
305 RPP5	305
325 RPP5	325
345 RPP5	345
350 RPP5	350
375 RPP5	375
400 RPP5	400
420 RPP5	420
425 RPP5	425
450 RPP5	450
455 RPP5	455
460 RPP5	460
465 RPP5	465
475 RPP5	475
500 RPP5	500
525 RPP5	525
535 RPP5	535
565 RPP5	565
575 RPP5	575
580 RPP5	580
600 RPP5	600
610 RPP5	610
615 RPP5	615
635 RPP5	635
640 RPP5	640
670 RPP5	670
675 RPP5	675
700 RPP5	700
705 RPP5	705
710 RPP5	710
725 RPP5	725
740 RPP5	740
750 RPP5	750
755 RPP5	755
800 RPP5	800
835 RPP5	835
850 RPP5	850
890 RPP5	890
900 RPP5	900
935 RPP5	935
940 RPP5	940
950 RPP5	950
980 RPP5	980
1000 RPP5	1000
1025 RPP5	1025
1050 RPP5	1050
1100 RPP5	1100
1125 RPP5	1125
1135 RPP5	1135
1195 RPP5	1195
1200 RPP5	1200
1240 RPP5	1240
1270 RPP5	1270
1420 RPP5	1420
1500 RPP5	1500
1595 RPP5	1595
1605 RPP5	1605
1690 RPP5	1690
1790 RPP5	1790
1800 RPP5	1800
1870 RPP5	1870
1895 RPP5	1895
1945 RPP5	1945
2000 RPP5	2000
2250 RPP5	2250
2525 RPP5	2525
P 5	
H <sub>1</sub>	2
H	3,8

<b>RPP8</b>	
Označení	vrcholová délka (mm)
288 RPP8	288
320 RPP8	320
352 RPP8	352
360 RPP8	360
384 RPP8	384
408 RPP8	408
416 RPP8	416
456 RPP8	456
480 RPP8	480
536 RPP8	536
544 RPP8	544
560 RPP8	560
600 RPP8	600
608 RPP8	608
632 RPP8	632
640 RPP8	640
680 RPP8	680
720 RPP8	720
800 RPP8	800
840 RPP8	840
880 RPP8	880
896 RPP8	896
920 RPP8	920
960 RPP8	960
1000 RPP8	1000
1040 RPP8	1040
1080 RPP8	1080
1120 RPP8	1120
1200 RPP8	1200
1224 RPP8	1224
1280 RPP8	1280
1352 RPP8	1352
1424 RPP8	1424
1440 RPP8	1440
1464 RPP8	1464
1600 RPP8	1600
1680 RPP8	1680
1760 RPP8	1760
1800 RPP8	1800
2000 RPP8	2000
2200 RPP8	2200
2272 RPP8	2272
2400 RPP8	2400
2520 RPP8	2520
2600 RPP8	2600
2800 RPP8	2800
3048 RPP8	3048
3280 RPP8	3280
3600 RPP8	3600
4400 RPP8	4400
P 8	
H <sub>1</sub>	3,2
H	5,4

**RPP14**

Označení	vrcholová délka (mm)
966 RPP14	966
994 RPP14	994
1092 RPP14	1092
1106 RPP14	1106
1190 RPP14	1190
1260 RPP14	1260
1288 RPP14	1288
1344 RPP14	1344
1400 RPP14	1400
1442 RPP14	1442
1568 RPP14	1568
1610 RPP14	1610
1750 RPP14	1750
1764 RPP14	1764
1778 RPP14	1778
1848 RPP14	1848
1890 RPP14	1890
1904 RPP14	1904
1960 RPP14	1960
2100 RPP14	2100
2240 RPP14	2240
2310 RPP14	2310
2380 RPP14	2380
2450 RPP14	2450
2590 RPP14	2590
2660 RPP14	2660
2800 RPP14	2800
2968 RPP14	2968
3150 RPP14	3150
3360 RPP14	3360
3500 RPP14	3500
3850 RPP14	3850
3920 RPP14	3920
4326 RPP14	4326
4578 RPP14	4578
4956 RPP14	4956

P	14
H <sub>1</sub>	6
H	9,7

**RPP20**

Označení	vrcholová délka (mm)
2000 RPP20	2000
2500 RPP20	2500
3400 RPP20	3400
3800 RPP20	3800
4200 RPP20	4200
4600 RPP20	4600

P	20
H <sub>1</sub>	8,3
H	14,5

**RPP5 SILVER**

Označení	vrcholová délka (mm)
180-SLV5	180
225-SLV5	225
235-SLV5	235
245-SLV5	245
255-SLV5	255
265-SLV5	265
270-SLV5	270
280-SLV5	280
285-SLV5	285
295-SLV5	295
300-SLV5	300
305-SLV5	305
325-SLV5	325
345-SLV5	345
350-SLV5	350
375-SLV5	375
400-SLV5	400
420-SLV5	420
425-SLV5	425
450-SLV5	450
455-SLV5	455
460-SLV5	460
465-SLV5	465
475-SLV5	475
500-SLV5	500
525-SLV5	525
535-SLV5	535
565-SLV5	565
575-SLV5	575
580-SLV5	580
600-SLV5	600
610-SLV5	610
615-SLV5	615
635-SLV5	635
640-SLV5	640
670-SLV5	670
675-SLV5	675
700-SLV5	700
705-SLV5	705
710-SLV5	710
725-SLV5	725
740-SLV5	740
750-SLV5	750
755-SLV5	755
800-SLV5	800
835-SLV5	835
850-SLV5	850
890-SLV5	890
900-SLV5	900
935-SLV5	935
940-SLV5	940
950-SLV5	950
980-SLV5	980
1000-SLV5	1000
1025-SLV5	1025
1050-SLV5	1050
1100-SLV5	1100
1125-SLV5	1125
1135-SLV5	1135
1195-SLV5	1195
1200-SLV5	1200
1240-SLV5	1240
1270-SLV5	1270
1420-SLV5	1420
1500-SLV5	1500
1595-SLV5	1595
1605-SLV5	1605
1690-SLV5	1690
1790-SLV5	1790
1800-SLV5	1800
1870-SLV5	1870
1895-SLV5	1895
1945-SLV5	1945
2000-SLV5	2000
2250-SLV5	2250
2525-SLV5	2525

P	5
H <sub>1</sub>	2
H	3,8

**RPP8 SILVER**

Označení	vrcholová délka (mm)
288-SLV8	288
320-SLV8	320
352-SLV8	352
360-SLV8	360
384-SLV8	384
408-SLV8	408
416-SLV8	416
456-SLV8	456
480-SLV8	480
536-SLV8	536
544-SLV8	544
560-SLV8	560
600-SLV8	600
608-SLV8	608
632-SLV8	632
640-SLV8	640
680-SLV8	680
720-SLV8	720
800-SLV8	800
840-SLV8	840
880-SLV8	880
896-SLV8	896
920-SLV8	920
960-SLV8	960
1000-SLV8	1000
1040-SLV8	1040
1080-SLV8	1080
1120-SLV8	1120
1200-SLV8	1200
1224-SLV8	1224
1280-SLV8	1280
1352-SLV8	1352
1424-SLV8	1424
1440-SLV8	1440
1464-SLV8	1464
1600-SLV8	1600
1680-SLV8	1680
1760-SLV8	1760
1800-SLV8	1800
2000-SLV8	2000
2200-SLV8	2200
2272-SLV8	2272
2400-SLV8	2400
2520-SLV8	2520
2600-SLV8	2600
2800-SLV8	2800
3048-SLV8	3048
3280-SLV8	3280
3600-SLV8	3600
4400-SLV8	4400

P	8
H <sub>1</sub>	3,2
H	5,4

**RPP14 SILVER**

Označení	vrcholová délka (mm)
966-SLV14	966
994-SLV14	994
1092-SLV14	1092
1106-SLV14	1106
1190-SLV14	1190
1260-SLV14	1260
1288-SLV14	1288
1344-SLV14	1344
1400-SLV14	1400
1442-SLV14	1442
1568-SLV14	1568
1610-SLV14	1610
1750-SLV14	1750
1764-SLV14	1764
1778-SLV14	1778
1848-SLV14	1848
1890-SLV14	1890
1904-SLV14	1904
1960-SLV14	1960
2100-SLV14	2100
2240-SLV14	2240
2310-SLV14	2310
2380-SLV14	2380
2450-SLV14	2450
2590-SLV14	2590
2660-SLV14	2660
2800-SLV14	2800
2968-SLV14	2968
3150-SLV14	3150
3360-SLV14	3360
3500-SLV14	3500
3850-SLV14	3850
3920-SLV14	3920
4326-SLV14	4326
4578-SLV14	4578
4956-SLV14	4956

P	14
H <sub>1</sub>	6
H	9,7

**RPP8 GOLD**

Označení	vrcholová délka (mm)
288-GLD8	288
320-GLD8	320
352-GLD8	352
360-GLD8	360
384-GLD8	384
408-GLD8	408
416-GLD8	416
456-GLD8	456
480-GLD8	480
536-GLD8	536
544-GLD8	544
560-GLD8	560
600-GLD8	600
608-GLD8	608
632-GLD8	632
640-GLD8	640
680-GLD8	680
720-GLD8	720
800-GLD8	800
840-GLD8	840
880-GLD8	880
896-GLD8	896
920-GLD8	920
960-GLD8	960
1000-GLD8	1000
1040-GLD8	1040
1080-GLD8	1080
1120-GLD8	1120
1200-GLD8	1200
1224-GLD8	1224
1280-GLD8	1280
1352-GLD8	1352
1424-GLD8	1424
1440-GLD8	1440
1464-GLD8	1464
1600-GLD8	1600
1680-GLD8	1680
1760-GLD8	1760
1800-GLD8	1800
2000-GLD8	2000
2200-GLD8	2200
2272-GLD8	2272
2400-GLD8	2400
2520-GLD8	2520
2600-GLD8	2600
2800-GLD8	2800
3048-GLD8	3048
3280-GLD8	3280
3600-GLD8	3600
4400-GLD8	4400

P	8
H <sub>1</sub>	3,2
H	5,4

**RPP14 GOLD**

Označení	vrcholová délka (mm)
966-GLD14	966
994-GLD14	994
1092-GLD14	1092
1106-GLD14	1106
1190-GLD14	1190
1260-GLD14	1260
1288-GLD14	1288
1344-GLD14	1344
1400-GLD14	1400
1442-GLD14	1442
1568-GLD14	1568
1610-GLD14	1610
1750-GLD14	1750
1764-GLD14	1764
1778-GLD14	1778
1848-GLD14	1848
1890-GLD14	1890
1904-GLD14	1904
1960-GLD14	1960
2100-GLD14	2100
2240-GLD14	2240
2310-GLD14	2310
2380-GLD14	2380
2450-GLD14	2450
2590-GLD14	2590
2660-GLD14	2660
2800-GLD14	2800
2968-GLD14	2968
3150-GLD14	3150
3360-GLD14	3360
3500-GLD14	3500
3850-GLD14	3850
3920-GLD14	3920
4326-GLD14	4326
4578-GLD14	4578
4956-GLD14	4956

P	14
H <sub>1</sub>	6
H	9,7



### MXL - XL - L - H - XXH

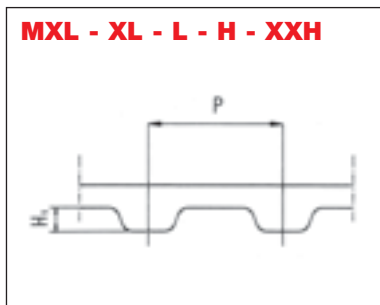

### XLDD - LDD - HDD

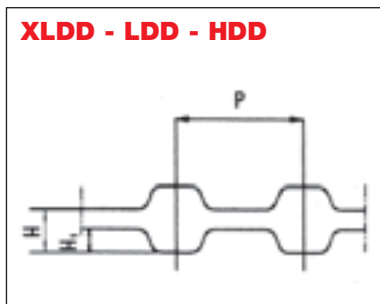

### RPP5 DD - RPP8 DD - RPP14 DD

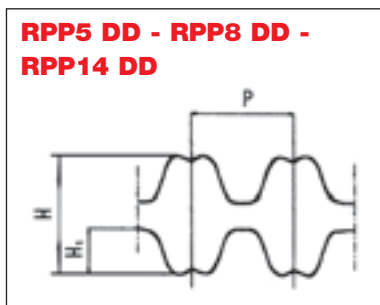

MXL	
Označení	vrcholová délka (mm)
360 MXL	91,44
432 MXL	109,73
440 MXL	111,76
456 MXL	115,82
480 MXL	121,92
488 MXL	123,95
496 MXL	125,98
536 MXL	136,14
544 MXL	138,18
576 MXL	146,30
584 MXL	148,34
608 MXL	154,43
632 MXL	160,53
640 MXL	162,56
656 MXL	166,62
664 MXL	168,66
680 MXL	172,72
704 MXL	178,82
720 MXL	182,88
736 MXL	186,94
752 MXL	191,00
760 MXL	193,04
776 MXL	197,10
800 MXL	203,20
808 MXL	205,23
824 MXL	209,30
840 MXL	213,36
880 MXL	223,52
888 MXL	225,55
912 MXL	231,65
920 MXL	233,68
944 MXL	239,78
952 MXL	241,81
960 MXL	243,84
976 MXL	247,90
984 MXL	249,94
1000 MXL	254,00
1008 MXL	256,03
1016 MXL	258,06
1040 MXL	264,16
1056 MXL	268,22
1072 MXL	272,29
1120 MXL	284,48
1160 MXL	294,64
1176 MXL	298,70
1184 MXL	300,74
1200 MXL	304,80
1224 MXL	310,90
1280 MXL	325,12
1400 MXL	355,60
1472 MXL	373,89
1496 MXL	379,98
1520 MXL	386,08
1600 MXL	406,40
1680 MXL	426,72
1696 MXL	430,78
1768 MXL	449,07
1800 MXL	457,20
1832 MXL	465,33
1856 MXL	471,42
1888 MXL	479,55
1984 MXL	503,94
1992 MXL	505,97
2048 MXL	520,19
2240 MXL	568,96
2360 MXL	599,44
2384 MXL	605,54
2480 MXL	629,92
2496 MXL	633,98
2520 MXL	640,08
2584 MXL	656,34
2776 MXL	705,10
2864 MXL	727,46
2880 MXL	731,52
2976 MXL	755,90
3064 MXL	778,26
3104 MXL	788,42
3200 MXL	812,80
3296 MXL	837,18
3424 MXL	869,70
3472 MXL	881,89
3480 MXL	883,92

MXL	
Označení	vrcholová délka (mm)
3520 MXL	894,08
3632 MXL	922,53
3704 MXL	940,82
3944 MXL	1001,78
4000 MXL	1016,00
4064 MXL	1032,26
4200 MXL	1066,80
4280 MXL	1087,12
4320 MXL	1097,28
4456 MXL	1131,82
4736 MXL	1202,94
4800 MXL	1219,20
5224 MXL	1326,90

P	2,032
H <sub>1</sub>	0,51
H	1,14

XL	
Označení	vrcholová délka (mm)
54 XL	137,16
60 XL	152,40
70 XL	177,80
80 XL	203,20
90 XL	228,60
98 XL	248,92
100 XL	254,00
102 XL	259,08
104 XL	264,16
106 XL	269,24
110 XL	279,40
120 XL	304,80
130 XL	330,20
140 XL	355,60
146 XL	370,84
150 XL	381,00
156 XL	396,24
160 XL	406,40
170 XL	431,80
176 XL	447,04
180 XL	457,20
182 XL	462,28
188 XL	477,52
190 XL	482,60
198 XL	502,92
200 XL	508,00
202 XL	513,08
210 XL	533,40
212 XL	538,48
214 XL	543,56
220 XL	558,80
228 XL	579,12
230 XL	584,20
234 XL	594,36
240 XL	609,60
250 XL	635,00
260 XL	660,40
270 XL	685,80
276 XL	701,04
290 XL	736,60
310 XL	787,40
316 XL	802,64
320 XL	812,80
330 XL	838,20
344 XL	873,76
352 XL	894,08
364 XL	924,56
380 XL	965,20
384 XL	975,36
388 XL	985,52
390 XL	990,60
392 XL	995,68
434 XL	1102,36
460 XL	1168,40
530 XL	1346,20
600 XL	1524,00
710 XL	1803,40

P	5,08
H <sub>1</sub>	1,27
H	2,4

L	
Označení	vrcholová délka (mm)
124 L	314,96
135 L	342,90
150 L	381,00
173 L	439,42
187 L	476,25
202 L	513,80
210 L	533,40
225 L	571,50
240 L	609,60
255 L	647,70
270 L	685,80
285 L	723,90
300 L	762,00
322 L	819,15
334 L	848,36
345 L	876,30
367 L	933,45
390 L	990,60
405 L	1028,70
412 L	1047,75
420 L	1066,80
450 L	1143,00
480 L	1219,20
510 L	1295,40
540 L	1371,60
600 L	1524,00
728 L	1847,85
817 L	2076,45

P	9,525
H <sub>1</sub>	1,91
H	3,6

H	
Označení	vrcholová délka (mm)
240 H	609,60
270 H	685,80
300 H	762,00
330 H	838,00
360 H	914,40
390 H	990,60
420 H	1066,80
450 H	1143,00
480 H	1219,20
510 H	1295,40
540 H	1371,60
570 H	1447,80
600 H	1524,00
630 H	1600,20
660 H	1676,40
670 H	1701,80
700 H	1778,00
725 H	1841,50
750 H	1905,00
800 H	2032,00
850 H	2159,00
900 H	2286,00
1000 H	2540,00
1100 H	2794,00
1120 H	2844,80
1140 H	2895,60
1150 H	2921,00
1250 H	3175,00
1400 H	3556,00
1645 H	4178,30
1700 H	4318,00

P	12,7
H <sub>1</sub>	2,29
H	4,4

XH	
Označení	vrcholová délka (mm)
507 XH	1289,00
534 XH	1356,36
560 XH	1422,40
630 XH	1600,20
700 XH	1778,00
770 XH	1955,80
840 XH	2133,60
980 XH	2489,20
1120 XH	2844,80
1260 XH	3200,40
1400 XH	3566,00
1540 XH	3911,60
1750 XH	4445,00

P	22,225
H <sub>1</sub>	6,22
H	11,4

XXH	
Označení	vrcholová délka (mm)
700 XXH	1778,0
800 XXH	2032,0
900 XXH	2286,0
1000 XXH	2540,0
1200 XXH	3048,0
1400 XXH	3556,0
1600 XXH	4064,0
1800 XXH	4572,0

P	31,75
H <sub>1</sub>	9,53
H	15,3



<b>XLDD</b>	
Označení	vrcholová délka (mm)
DD 120 XL	304,80
DD 130 XL	330,20
DD 140 XL	355,60
DD 146 XL	370,84
DD 150 XL	381,00
DD 156 XL	396,24
DD 160 XL	406,40
DD 170 XL	431,80
DD 176 XL	447,04
DD 180 XL	457,20
DD 182 XL	462,28
DD 188 XL	477,52
DD 190 XL	482,60
DD 198 XL	502,92
DD 200 XL	508,00
DD 202 XL	513,08
DD 210 XL	533,40
DD 212 XL	538,48
DD 214 XL	543,56
DD 220 XL	558,80
DD 228 XL	579,12
DD 230 XL	584,20
DD 234 XL	594,36
DD 240 XL	609,60
DD 250 XL	635,00
DD 260 XL	660,40
DD 270 XL	685,80
DD 276 XL	701,04
DD 290 XL	736,60
DD 310 XL	787,40
DD 316 XL	802,64
DD 320 XL	812,80
DD 330 XL	838,20
DD 344 XL	873,76
DD 352 XL	894,08
DD 364 XL	924,56
DD 380 XL	965,20
DD 384 XL	975,36
DD 388 XL	985,52
DD 390 XL	990,60
DD 392 XL	995,68
DD 434 XL	1102,36
DD 460 XL	1168,40
DD 530 XL	1346,20
DD 600 XL	1524,00
DD 710 XL	1803,40

P	5,08
H <sub>1</sub>	1,27
H	3,05

<b>LDD</b>	
Označení	vrcholová délka (mm)
DD 124 L	314,96
DD 135 L	342,90
DD 150 L	381,00
DD 173 L	439,42
DD 187 L	474,98
DD 202 L	513,08
DD 210 L	533,40
DD 225 L	571,50
DD 240 L	609,60
DD 255 L	647,70
DD 270 L	685,80
DD 285 L	723,90
DD 300 L	762,00
DD 322 L	817,88
DD 334 L	848,36
DD 345 L	876,30
DD 367 L	932,18
DD 390 L	990,60
DD 405 L	1028,70
DD 412 L	1046,48
DD 420 L	1066,80
DD 450 L	1143,00
DD 480 L	1219,20
DD 510 L	1295,40
DD 540 L	1371,60
DD 600 L	1524,00
DD 728 L	1849,12
DD 817 L	2075,18

P	9,525
H <sub>1</sub>	1,91
H	4,6

<b>HDD</b>	
Označení	vrcholová délka (mm)
DD 240 H	609,60
DD 270 H	685,80
DD 300 H	762,00
DD 330 H	838,20
DD 360 H	914,40
DD 390 H	990,60
DD 420 H	1066,80
DD 450 H	1143,00
DD 480 H	1219,20
DD 510 H	1295,40
DD 540 H	1371,60
DD 570 H	1447,80
DD 600 H	1524,00
DD 630 H	1600,20
DD 660 H	1676,40
DD 670 H	1701,80
DD 700 H	1778,00
DD 725 H	1841,50
DD 750 H	1905,00
DD 800 H	2032,00
DD 850 H	2159,00
DD 900 H	2286,00
DD 1000 H	2540,00
DD 1100 H	2794,00
DD 1120 H	2844,80
DD 1140 H	2895,60
DD 1150 H	2921,00
DD 1250 H	3175,00
DD 1400 H	3556,00
DD 1645 H	4178,30
DD 1700 H	4318,00

P	12,7
H <sub>1</sub>	2,29
H	5,9

<b>RPP5 DD</b>	
Označení	vrcholová délka (mm)
600 RPP5 DD	600
610 RPP5 DD	610
615 RPP5 DD	615
635 RPP5 DD	635
640 RPP5 DD	640
670 RPP5 DD	670
675 RPP5 DD	675
700 RPP5 DD	700
705 RPP5 DD	705
710 RPP5 DD	710
725 RPP5 DD	725
740 RPP5 DD	740
750 RPP5 DD	750
755 RPP5 DD	755
800 RPP5 DD	800
835 RPP5 DD	835
850 RPP5 DD	850
890 RPP5 DD	890
900 RPP5 DD	900
935 RPP5 DD	935
940 RPP5 DD	940
950 RPP5 DD	950
980 RPP5 DD	980
1000 RPP5 DD	1000
1025 RPP5 DD	1025
1050 RPP5 DD	1050
1100 RPP5 DD	1100
1125 RPP5 DD	1125
1135 RPP5 DD	1135
1195 RPP5 DD	1195
1200 RPP5 DD	1200
1240 RPP5 DD	1240
1270 RPP5 DD	1270
1420 RPP5 DD	1420
1500 RPP5 DD	1500
1595 RPP5 DD	1595
1605 RPP5 DD	1605
1690 RPP5 DD	1690
1790 RPP5 DD	1790
1800 RPP5 DD	1800
1870 RPP5 DD	1870
1895 RPP5 DD	1895
1945 RPP5 DD	1945
2000 RPP5 DD	2000
2250 RPP5 DD	2250
2525 RPP5 DD	2525

P	5
H <sub>1</sub>	2
H	5,2

<b>RPP8 DD</b>	
Označení	vrcholová délka (mm)
600 RPP8 DD	600
608 RPP8 DD	608
632 RPP8 DD	632
640 RPP8 DD	640
680 RPP8 DD	680
720 RPP8 DD	720
800 RPP8 DD	800
840 RPP8 DD	840
880 RPP8 DD	880
896 RPP8 DD	896
920 RPP8 DD	920
960 RPP8 DD	960
1000 RPP8 DD	1000
1040 RPP8 DD	1040
1080 RPP8 DD	1080
1120 RPP8 DD	1120
1200 RPP8 DD	1200
1224 RPP8 DD	1224
1280 RPP8 DD	1280
1352 RPP8 DD	1352
1424 RPP8 DD	1424
1440 RPP8 DD	1440
1464 RPP8 DD	1464
1600 RPP8 DD	1600
1680 RPP8 DD	1680
1760 RPP8 DD	1760
1800 RPP8 DD	1800
2000 RPP8 DD	2000
2200 RPP8 DD	2200
2272 RPP8 DD	2272
2400 RPP8 DD	2400
2520 RPP8 DD	2520
2600 RPP8 DD	2600
2800 RPP8 DD	2800
3048 RPP8 DD	3048
3280 RPP8 DD	3280
3600 RPP8 DD	3600
4400 RPP8 DD	4400

P	8
H <sub>1</sub>	3,2
H	7,8

<b>RPP14 DD</b>	
Označení	vrcholová délka (mm)
966 RPP14 DD	966
994 RPP14 DD	994
1092 RPP14 DD	1092
1106 RPP14 DD	1106
1190 RPP14 DD	1190
1260 RPP14 DD	1260
1288 RPP14 DD	1288
1344 RPP14 DD	1344
1400 RPP14 DD	1400
1442 RPP14 DD	1442
1568 RPP14 DD	1568
1610 RPP14 DD	1610
1750 RPP14 DD	1750
1764 RPP14 DD	1764
1778 RPP14 DD	1778
1848 RPP14 DD	1848
1890 RPP14 DD	1890
1904 RPP14 DD	1904
1960 RPP14 DD	1960
2100 RPP14 DD	2100
2240 RPP14 DD	2240
2310 RPP14 DD	2310
2380 RPP14 DD	2380
2450 RPP14 DD	2450
2590 RPP14 DD	2590
2660 RPP14 DD	2660
2800 RPP14 DD	2800
2968 RPP14 DD	2968
3150 RPP14 DD	3150
3360 RPP14 DD	3360
3500 RPP14 DD	3500
3850 RPP14 DD	3850
3920 RPP14 DD	3920
4326 RPP14 DD	4326
4578 RPP14 DD	4578
4956 RPP14 DD	4956

P	14
H <sub>1</sub>	6
H	13,7

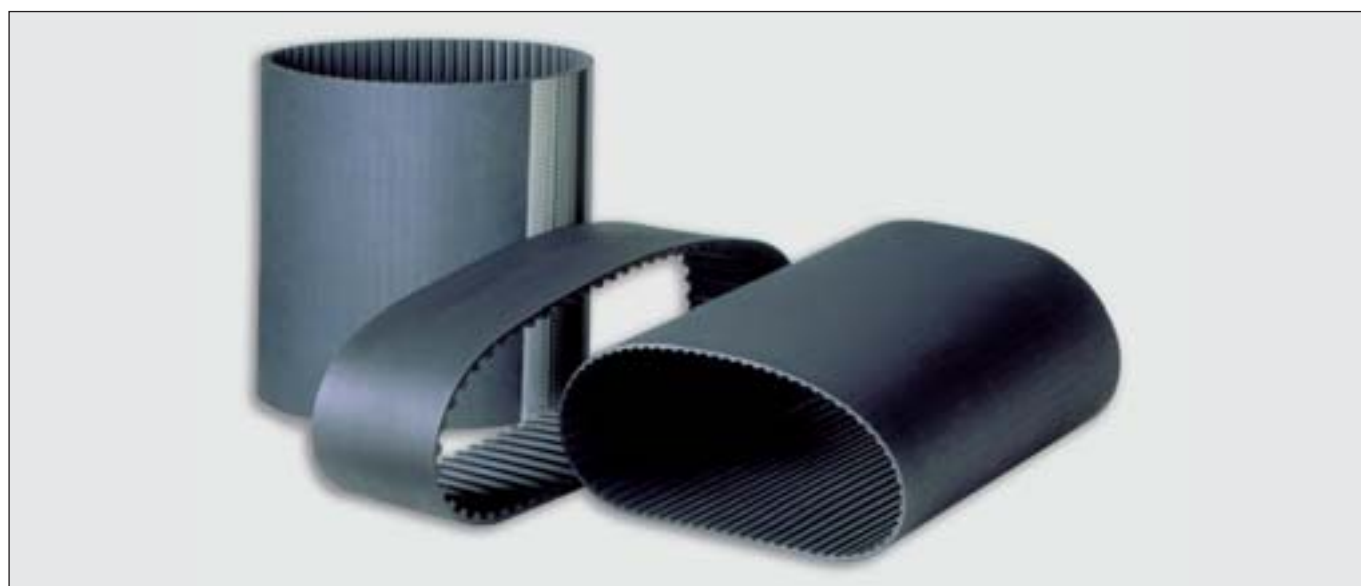



# SYNCHRONNÍ GUMOVÉ ŘEMENY V METRÁŽI





### Synchronní gumové řemeny v metráži

Jsou obzvlášť vhodné pro lineární pohony a zpětný chod.

Vysoká kapacita zatížení, nulové náklady na údržbu, a nízká hladina hluku předurčují tyto řemeny jako vynikající alternativu k řetězovým a lankovým převodům.

Megadyne neoprenové řemeny v metráži se vyrábějí v následujících provedeních:

- ISORAN® – MXL, XL, L, H
- ISORAN® RPP – RPP3, RPP5, RPP8
- ISORAN® RPP SILVER – SLV5, SLV8
- STD – STD8

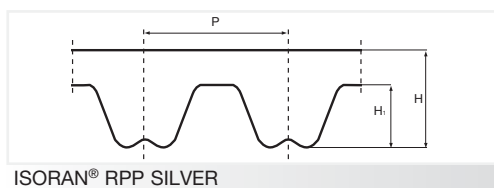
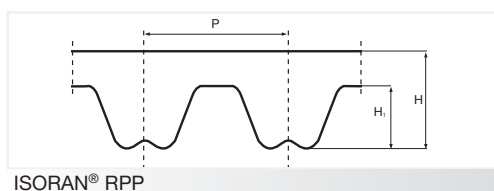
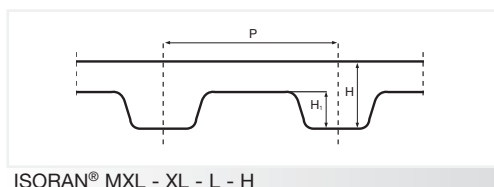

	<b>MXL</b>	<b>XL</b>	<b>L</b>	<b>H</b>
	standardní šíře (palce)	standardní šíře (palce)	standardní šíře (palce)	standardní šíře (palce)
	0.25 0.31 0.37	0.25 0.31 0.37	0.50 0.75 1.00	0.50 0.75 1.00 1.50 2.00 3.00
P	2.032	5.08	9.525	12.7
H	1.14	2.4	3.6	4.4
H <sub>1</sub>	0.51	1.27	1.91	2.29

	<b>RPP3</b>	<b>RPP5</b>	<b>RPP8</b>
	standardní šíře (mm)	standardní šíře (mm)	standardní šíře (mm)
	9 12 15	9 12 15 20 25 30	10 15 20 25 30 50 85
P	3	5	8
H	2,4	3,8	5,4
H <sub>1</sub>	1,15	2	3,2

	<b>SLV5</b>	<b>SLV8</b>	<b>STD8 M</b>
	standardní šíře (mm)	standardní šíře (mm)	standardní šíře (mm)
	15 25 30	10 15 20 30 50 85	10 20 30 50 85
P	5	8	8
H	3,8	5,4	5,3
H <sub>1</sub>	2	3,2	3,05

- kromě standardní šíře možno dodat jakoukoliv jinou šíři





**MEGAFLAT** jsou skutečně nekonečné řemeny, dostupné jak v polyuretanovém, tak v neoprenovém provedení – s polyesterovou, aramidovou nebo bavlněnou výstuhou. Standardně se vyrábějí v rukávech o šíři 330 mm, možné je ale dodat jakoukoliv požadovanou šíři.

#### Vlastnosti řemenů MEGAFLAT:

- vysoká flexibilita
- malý průměr řemenice
- rozměrová přesnost
- vysoká pracovní rychlost
- vysoká pevnost
- nízká hlučnost a vibrace
- nízké náklady na údržbu
- dobrá chemická odolnost a odolnost vůči ozonu
- vysoký koeficient tření povrchu

Řemeny **MEGAFLAT** je možno použít pro přenos síly nebo jako dopravní řemeny.

#### TAŽNÝ ELEMENT

INSTALOVANÉ PNUTÍ x cm ŠÍŘKA (N) NEKONEČNÉ  
 MIN. PRŮMĚR ŘEMENICE mm  
 TLOUŠŤKA mm  
 STANDARDNÍ DÉLKA mm  
 POVRCHOVÁ VRSTVA  
 ANTISTATICKÝ

#### T 75

polyesterová tkanina
150
6
0,5
200/3850
NEOPREN
ANO

#### T 150

polyesterová tkanina
300
15
0,9
200/3850
NEOPREN
ANO

#### T 200

polyesterová tkanina
400
20
1,1
200/3850
NEOPREN
ANO

#### TAŽNÝ ELEMENT

INSTALOVANÉ PNUTÍ x cm ŠÍŘKA (N) NEKONEČNÉ  
 MIN. PRŮMĚR ŘEMENICE mm  
 TLOUŠŤKA mm  
 STANDARDNÍ DÉLKA mm  
 POVRCHOVÁ VRSTVA  
 ANTISTATICKÝ

#### P 0

bez tkaniny
–
8
0,9
240/1200
POLYURETAN
NE

#### P 102

elastická tkanina/nylon
10
25
1,8
240/2500
POLYURETAN
MOŽNÝ

#### P 108

polyester/bavlna
200
5
0,8
240/3850
POLYURETAN
MOŽNÝ

#### P 110

polyesterová tkanina
150
12
1
240/3850
POLYURETAN
MOŽNÝ

#### TAŽNÝ ELEMENT

INSTALOVANÉ PNUTÍ x cm ŠÍŘKA (N) NEKONEČNÉ  
 MIN. PRŮMĚR ŘEMENICE mm  
 TLOUŠŤKA mm  
 STANDARDNÍ DÉLKA mm  
 POVRCHOVÁ VRSTVA  
 ANTISTATICKÝ

#### P 120

polyesterová tkanina
350
20
1,5
240/3850
POLYURETAN
MOŽNÝ

#### P 155

aramid/polyester
400
25
2
240/3850
POLYURETAN
MOŽNÝ

#### S 110

polyesterová tkanina
125
12
1,0
240/3850
SILIKON
MOŽNÝ



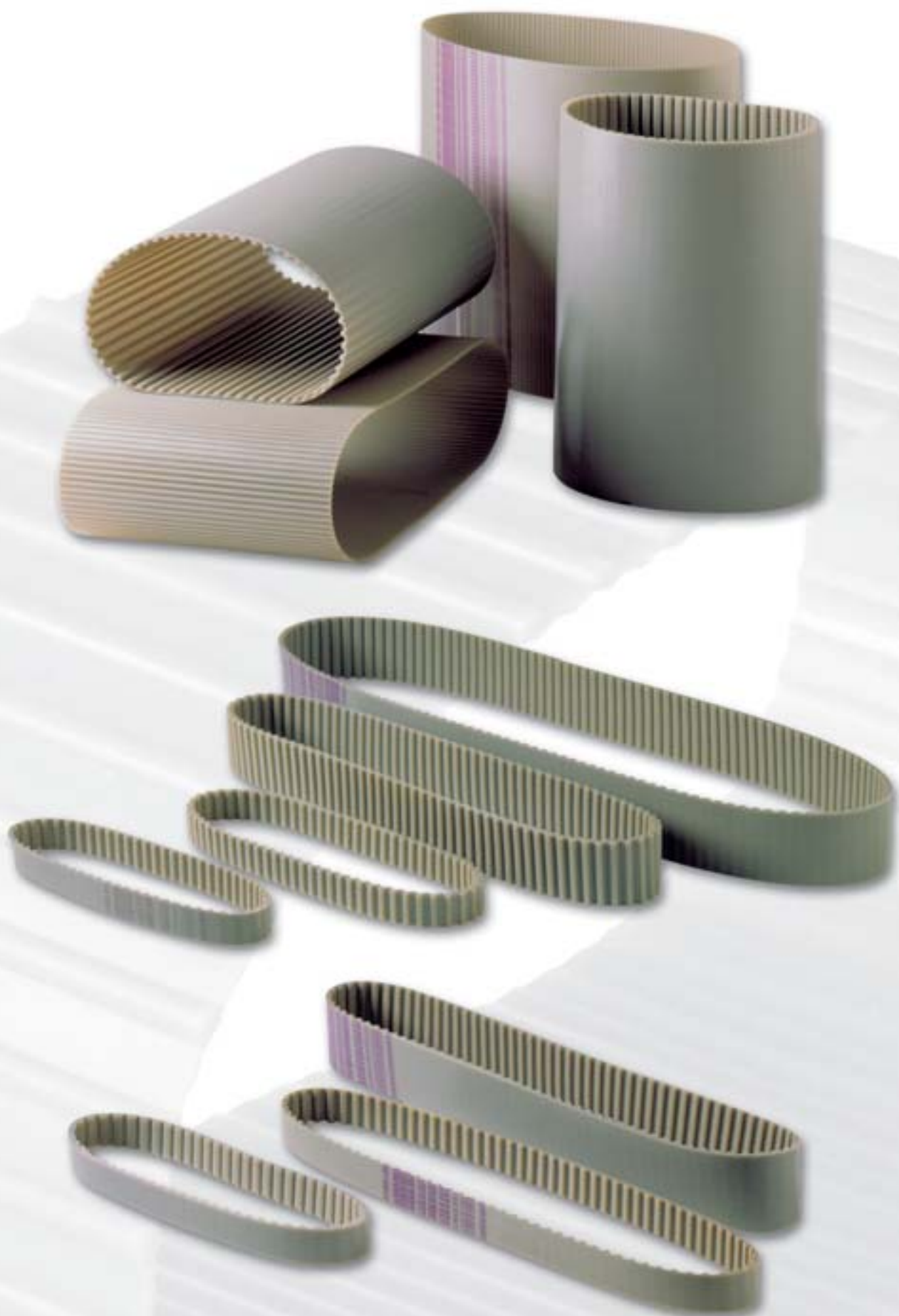



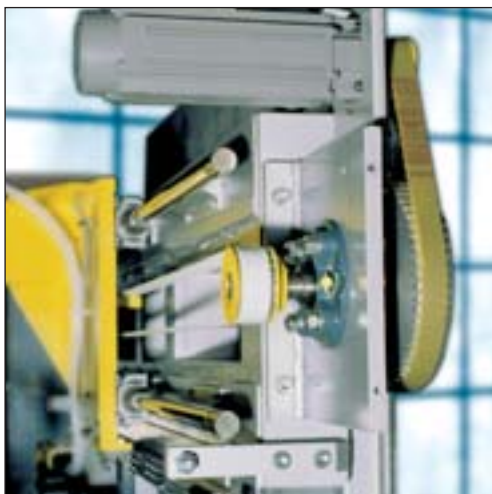

**MEGAPOWER** ozubené řemeny se vyrábějí z originálního termostálého polyuretanu za pomoci forem, které zaručují vysokou přesnost ozubení – v tzv. rukávech. Řezáním z rukávů se řemeny konkrétních šířek dodávají zákazníkům. Použitý polyuretan zaručuje vysokou odolnost vůči oděru, stříhu a v součinnosti s možností použít různé kordy zabezpečuje vysokou odolnost v tahu a vůči protržení. Výsledkem je řemen, který je rozměrově stálý a díky výrobě ve formách, které mají minimální toleranční rozsah, zaručuje naprosto shodnou délku a tloušťku. Pro některé aplikace je vhodné použít kevlarový kord – zejména v korozivním prostředí, zařízení pro snímání kovů a pro řemenice malých průměrů. Pro další speciální aplikace lze použít řemeny se skelným vláknem, kordy HP, HF nebo HPF. Kombinace těchto faktorů předurčuje řemeny Megapower pro provozy s nejvyššími požadavky na chemickou a fyzikální stálost.

**MEGAPOWER PU** řemeny jsou vhodné pro přenos velké síly, přesný chod a regulaci – a to zejména při vysokých rychlostech.

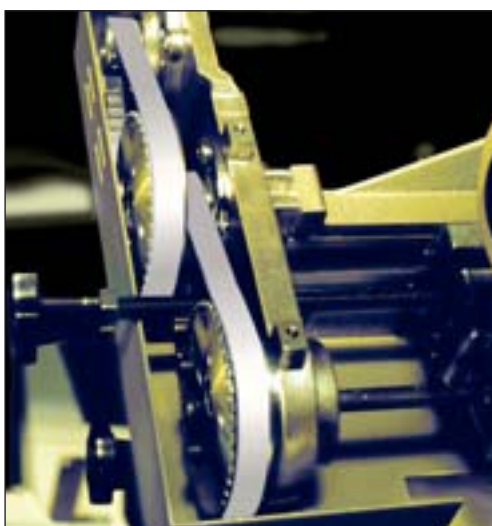

#### **MECHANICKÉ VLASTNOSTI:**

- konstantní rozměry
- nízké předpětí
- nízká hlučnost
- vysoká odolnost vůči oděru
- nulové náklady na údržbu
- vysoká pružnost
- lineární rychlosti do 80 m/s

#### **CHEMICKÉ VLASTNOSTI:**

- dobrá odolnost vůči – stárnutí, hydrolýze, UVA záření, ozonu
- rozsah pracovních teplot: -25°C - +80°C (krátkodobě do 110°C)
- vysoká odolnost vůči tukům, olejům a průmyslovým mazivům
- dobrá odolnost vůči většině kyselin a zásad

**MEGAPOWER PU** řemeny jsou zejména vhodné pro práci na lehce synchronních a krokových převodech, kancelářských přístrojích, zařízeních pro domácnost a pro většinu průmyslových aplikací.



## T2 - T2.5 - T5 - T10

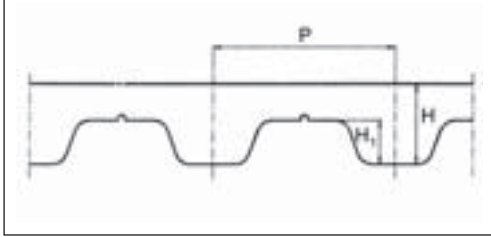

## T5 - T10\* možné také bez drážky

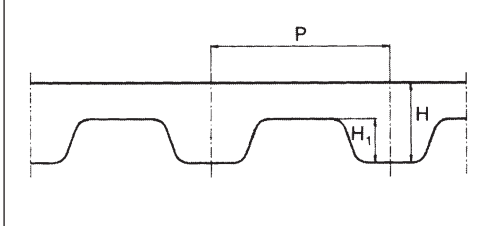

## T2.5 DL - T5 DL - T10 DL

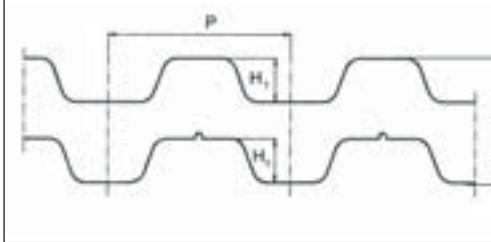

## AT5 - AT10

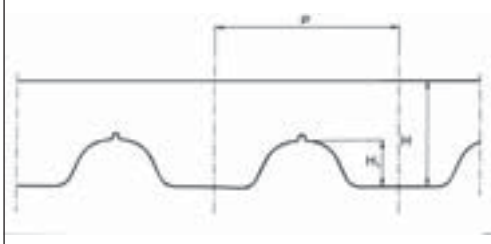

## MXL - XL - L - H

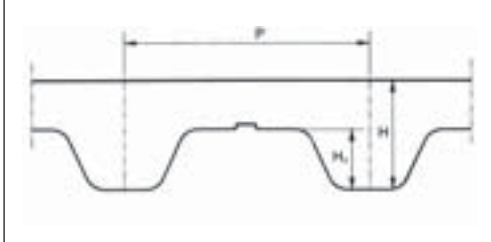

<b>T2.5</b>	
standardní šíře (mm)	4/6/8/10/12

<b>T5</b>	
standardní šíře (mm)	6/8/10/12/16/20/25

<b>T10</b>	
standardní šíře	10/12/16/20/25/32/50/75

<b>T2.5 DL</b>	
standardní šíře (mm)	4/6/8/10/12

<b>T2.5</b>	
Označení	vrcholová délka (mm)
120	120
145	145
160	160
177,5	177,5
180	180
182,5	182,5
200	200
210	210
230	230
245	245
265	265
277,5	277,5
285	285
290	290
305	305
317,5	317,5
330	330
342,5	342,5
380	380
420	420
480	480
500	500
540	540
600	600
620	620
650	650
680	680
700	700
780	780
880	880
915	915
950	950
1185	1185

<b>T5</b>	
Označení	vrcholová délka (mm)
120	120
150	150
165	165
180	180
185	185
200	200
210	210
215	215
220	220
225	225
245	245
250	250
255	255
260	260
270	270
275	275
280	280
295	295
300	300
305	305
330	330
340	340
350	350
355	355
365	365
375	375
390	390
400	400
410	410
420	420
425	425
440	440
445	445
450	450
455	455
460	460
475	475
480	480
500	500
510	510
515*	515*
525	525
545	545
550	550
560	560
560*	560*
575	575
590	590
600	600
610	610
620	620
630	630
640	640
650	650
660	660
675	675
690	690
700	700
720	720
725	725
750	750
765	765
780	780
800	800
815	815
830	830
840	840
850	850
860	860
885	885
900	900
920	920
940	940
990	990
1075	1075
1100	1100
1160	1160
1200	1200
1215	1215
1275	1275
1280	1280
1315	1315
1355	1355
1380	1380
1440	1440
1470	1470
1500	1500
1580	1580
1955	1955

<b>T10</b>	
Označení	vrcholová délka (mm)
260	260
320	320
340	340
370	370
390	390
400	400
410	410
440	440
450	450
480	480
500	500
530	530
550	550
560	560
600	600
600*	600*
610	610
630	630
630*	630*
650	650
660	660
680	680
690	690
700	700
720	720
720*	720*
730	730
750	750
780	780
800*	800*
810	810
840	840
850	850
880	880
890	890
900	900
900*	900*
910	910
920	920
920*	920*
950	950
960	960
970	970
980	980
1000	1000
1010	1010
1050	1050
1080	1080
1100	1100
1110	1110
1140	1140
1150	1150
1200	1200
1210	1210
1240	1240
1250	1250
1300	1300
1320	1320
1350	1350
1390	1390
1400	1400
1420	1420
1440	1440
1450	1450
1460	1460
1500	1500
1560	1560
1600	1600
1610	1610
1700	1700
1750	1750
1780	1780
1880	1880
1960	1960
2250	2250

<b>T2.5 DL</b>	
Označení	vrcholová délka (mm)
457,5 DL	457,5

P	2,5
H	1,3
H <sub>1</sub>	0,7

<b>T5 DL</b>	
standardní šíře (mm)	6/8/10/12/16/20/25

<b>T5 DL</b>	
Označení	vrcholová délka (mm)

410 DL	410
460 DL	460
515 DL	515
525 DL	525
550 DL	550
590 DL	590
620 DL	620
685 DL	685
700 DL	700
750 DL	750
815 DL	815
840 DL	840
860 DL	860
940 DL	940
1100 DL	1100

P	5
H	2,2
H <sub>1</sub>	1,2

<b>T10 DL</b>	
standardní šíře (mm)	10/12/16/20/25/32/50/75

<b>T10 DL</b>	
Označení	vrcholová délka (mm)

260 DL	260
530 DL	530
630 DL	630
660 DL	660
700 DL	700
720 DL	720
800 DL	800
840 DL	840
900 DL	900
920 DL	920
980 DL	980
1100 DL	1100
1210 DL	1210
1240 DL	1240
1250 DL	1250
1320 DL	1320
1350 DL	1350
1420 DL	1420
1610 DL	1610
1880 DL	1880

P	5
H	2,2
H <sub>1</sub>	1,2

P	10
H	4,5
H <sub>1</sub>	2,5

P	10
H	4,5
H <sub>1</sub>	2,5

\*řemeny se vyrábějí ve vakuovém provedení

**AT5**

standardní šíře (mm)  
6/8/10/12/16/20/25

**AT5**

Označení	vrcholová délka (mm)
225	225
255	255
275	275
280	280
300	300
330	330
340	340
375	375
390	390
420	420
450	450
455	455
480	480
500	500
525	525
545	545
600	600
610	610
630	630
660	660
670	670
710	710
720	720
750	750
780	780
825	825
860	860
975	975
1050	1050
1125	1125
1500	1500
2000	2000

P	5
H	2,7
H <sub>1</sub>	1,2

**AT10**

standardní šíře (mm)  
10/12/16/20/25/32/50/75

**AT10**

Označení	vrcholová délka (mm)
370	370
500	500
560	560
580	580
600	600
610	610
630	630
660	660
700	700
730	730
780	780
800	800
810	810
840	840
880	880
890	890
920	920
960	960
980	980
1000	1000
1010	1010
1050	1050
1080	1080
1100	1100
1150	1150
1200	1200
1210	1210
1220	1220
1230	1230
1240	1240
1250	1250
1280	1280
1300	1300
1320	1320
1350	1350
1360	1360
1400	1400
1420	1420
1480	1480
1500	1500
1600	1600
1630	1630
1700	1700
1720	1720
1800	1800
1860	1860
1940	1940

P	10
H	4,5
H <sub>1</sub>	2,5

**MXL**

standardní šíře (mm)  
3,2/4,8/6,4

**MXL**

Označení	vrcholová délka (mm)
80055	111,7
80057	115,8
80060	121,9
80070	142,2
80072	146,3
80075	152,4
80076	154,4
80079	160,5
80080	162,5
80082	166,6
80088	178,8
80091	184,9
80092	186,9
80096	195,1
80101	205,2
80102	207,2
80103	209,2
80105	213,3
80110	223,5
80114	231,6
80118	239,7
80120	243,8
80130	264,1
80132	268,2
80135	274,3
80140	284,4
80145	294,6
80150	304,8
80155	314,9
80175	355,6
80190	386,5
80200	406,8
80221	449,1
80256	520,1
80280	568,9
80285	579,1
80308	625,8
80332	674,6
80352	715,2
80360	731,5
80395	802,6
80405	822,9
80412	837,1
80432	877,8
80454	922,5
80485	985,5

P	2,032
H	1,2
H <sub>1</sub>	0,51

**XL**

standardní šíře (mm)  
6,4/7,9/9,4

**XL**

Označení	vrcholová délka (mm)
60	152,4
70	177,8
76	193,0
80	203,2
90	228,6
100	254,0
110	269,4
120	304,8
130	330,2
134	340,3
140	355,6
150	381,0
160	406,4
170	431,8
180	457,2
190	482,6
194	492,7
200	508,0
210	533,4
220	558,8
230	584,2
240	609,6
250	635,0
260	660,4
270	685,8
288	731,5
290	736,6
300	762,0
356	904,2
414	1051,5
450	1143,0
566	1437,6

P	5,080
H	2,25
H <sub>1</sub>	1,25

**L**

standardní šíře (mm)  
12,7/19,1/25,4

**L**

Označení	vrcholová délka (mm)
86	218,6
124	314,3
150	381,0
173	438,1
187	476,2
202	514,4
210	533,4
225	571,5
240	609,6
255	647,7
270	685,8
285	723,9
300	762,0
322	817,9
345	876,3
367	933,4
390	990,6
420	1066,8
450	1143,0
480	1219,2
510	1295,4
540	1371,6
570	1447,8
600	1524,0

P	9,525
H	3,6
H <sub>1</sub>	1,9

**H**

standardní šíře (mm)  
19,1/25,4/38,1/50,8/76,2

**H**

Označení	vrcholová délka (mm)
230	584,2
240	609,6
270	685,8
300	762,0
330	838,2
360	914,4
390	990,6
420	1066,8
450	1143,0
480	1219,2
510	1295,4

P	12,7
H	4,3
H <sub>1</sub>	2,29

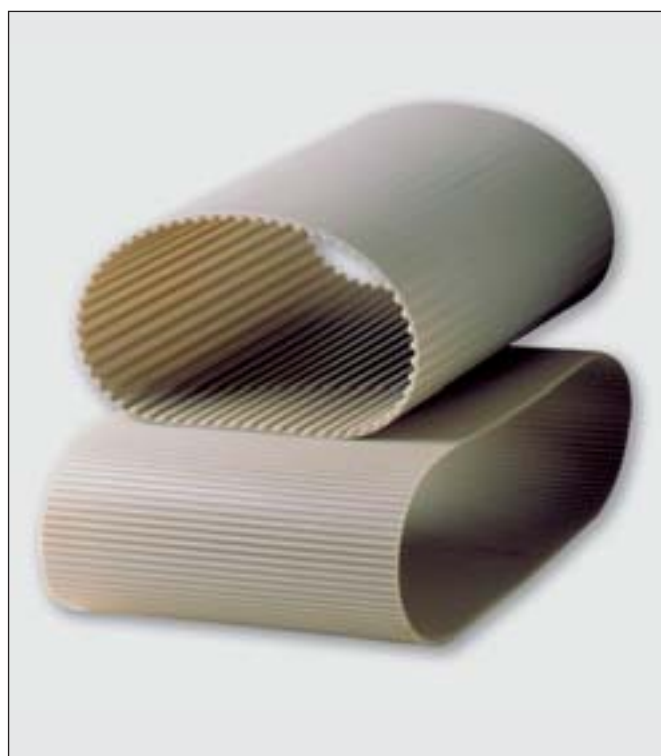







**MEGALINEAR** PU řemeny v metráži se vyrábějí z termoplastického polyuretanu, který zaručuje vysokou odolnost vůči oděru a opotřebení. Široká škála možností použít různé typy ocelových kordů nabízí dobré výkonové charakteristiky, které se nemění ani při vyšším stupni zatížení. Technologie výroby zaručuje minimální toleranční rozsahy, což dává řemenům Megalinear excelentní rozměrovou stabilitu a spolehlivost. Přidáním nylonového potahu ozubení nebo hřbetu (nebo obojího) přímo při výrobě řemenů, rozšiřuje možnosti využití těchto řemenů pro ty nejnáročnější aplikace. Extra tloušťka polyuretanu na hřbetu řemene umožňuje zvýšenou ochranu proti agresivním nebo těžkým materiálům při přepravě.

#### **MECHANICKÉ VLASTNOSTI:**

- konstantní rozměry
- nízké předpětí
- nízká hlučnost
- vysoká odolnost vůči oděru
- nulové náklady na údržbu
- vysoká pružnost
- lineární rychlosti do 80 m/s
- vysoká přesnost lineárního pohonu

#### **Chemické vlastnosti:**

- dobrá odolnost vůči – stárnutí, hydrolýze, UVA záření, ozonu
- rozsah pracovních teplot: -25°C až 80°C (krátkodobě 110°C)
- vysoká odolnost vůči tukům, olejům a průmyslovým mazivům
- dobrá odolnost vůči většině kyselin a zásad
- kompatibilita s jinými termoplastickými materiály

**MEGALINEAR** PU řemeny jsou dodávány jako otevřená metráž nebo jako řemeny spojené jedinečnou technologií na přesně požadovanou délku.

Metráž se vyrábí v rolích 50 a 100 m. Ostatní délky rolí jsou k dispozici na vyžádání.

#### **Spojené řemeny MEGALINEAR – svařovaná metráž**

Při svařování řemene se využívá právě termoplastických vlastností polyuretanu. Tímto způsobem je možno svařit řemen libovolného profilu na jakýkoliv rozměr, při zachování minimální délky, kterou je možno svařit. Výsledný spoj je odolný vůči únavě materiálu způsobené ohybem a tlakem na řemen a to díky unikátnímu symetrickému typu spoje V. Na tyto řemeny je možno navařovat různé typy unášeců a povrchových vrstev (extrudované nebo lepené vrstvy).

V poslední době se tyto typy řemenů začínají uplatňovat v lehčích a středně těžkých průmyslových aplikacích jako dopravní řemeny při přepravě různých materiálů a to i při vyšších rychlostech. V mnoha případech dokonce nahrazují i rozšířené dopravníkové pásy. Velkou výhodou je široká variabilita použitých profilů ozubení a možnost volby mnoha povrchových vrstev, které ještě vylepšují vlastnosti řemene.

MEGADYNE CZ s.r.o. jako jediná společnost v České republice disponuje profesionálním svařovacím zařízením.





## T5 - T10 - T20



## AT3 - AT5 - AT10 - AT20



## MTD 3M - MTD 5M - MTD 8M - MTD 14M



## STD 5M - STD 8M

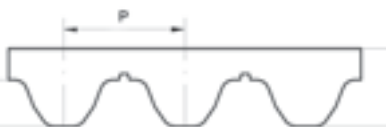

## RPP5 - RPP8 - RPP14

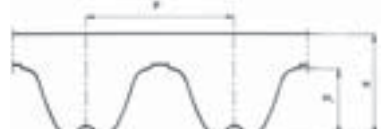

## XL - L - H - XH



## P1 - P2 - P3 - P4



## TG5 - TG10 - TG20 - ATG10 - ATG20 - HG

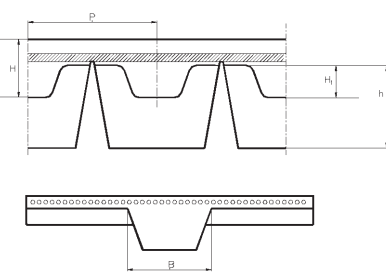

### MTD 3M

Standardní šíře (mm)
10
20
25
50

### MTD 5M

Standardní šíře (mm)
10
15
25
50

### MTD 8M

Standardní šíře (mm)
10
15
20
30
50
85
100

### MTD 14M

Standardní šíře (mm)
25
40
55
85
100
115

P	3	5	8	14
H	2,2	3,6	5,6	10
H <sub>1</sub>	1,13	2,1	3,4	6,1

### RPP5

Standardní šíře (mm)
10
15
25
30
50
75

### RPP8

Standardní šíře (mm)
10
15
20
30
50
85
100

### RPP14

Standardní šíře (mm)
40
55
85
115
150
40 XP
55 XP
85 XP
115 XP
150 XP

P	5	8	14
H	3,8	5,4	10
H <sub>1</sub>	2	3,2	6

### TG5 K6

Standardní šíře (mm)
25
32
50

### TG10 K6

Standardní šíře (mm)
50

### TG10 K13

Standardní šíře (mm)
25
32
50
75
100

### TG20 K13

Standardní šíře (mm)
50
75
100

P	5	10	10	20
H	2,2	4,5	4,5	8
H <sub>1</sub>	1,2	2,5	2,5	5
B	6	6	13	13
h	4	3,3	6,5	5,5

### ATG10 K13

Standardní šíře (mm)
25
32
50
75
100
150

### ATG20 K13

Standardní šíře (mm)
75
150

### HG K13

Standardní šíře (mm)
1,50
2,00
3,00
4,00

P	10	20	12.7
H	4,5	8	4.3
H <sub>1</sub>	2,5	5	2.29
B	13	13	13
h	7	6,4	6.29

<b>XL</b>	<b>L</b>	<b>H</b>	<b>H*</b>	<b>XH</b>
Standardní šíře (palce)	Standardní šíře (palce)	Standardní šíře (palce)	Standardní šíře (palce)	Standardní šíře (palce)
0.25	0.37	0.50	8.00	1.00
0.37	0.50	0.75	200.00	1.50
0.50	0.75	1.00		2.00
0.75	1.00	1.50		3.00
1.00	1.50	2.00		4.00
1.50	2.00	3.00		6.00
2.00	4.00	4.00		
		6.00		

P	5.08	P	9.525	P	12.7	P	12.7	P	22.225
H	2.3	H	3.6	H	4.3	H	4.3	H	11.2
H <sub>1</sub>	1.27	H <sub>1</sub>	1.90	H <sub>1</sub>	2.29	H <sub>1</sub>	2.29	H <sub>1</sub>	6.35

<b>T5</b>	<b>T10</b>	<b>T10*</b>	<b>T20</b>
Standardní šíře (mm)	Standardní šíře (mm)	Standardní šíře (mm)	Standardní šíře (mm)
6	12	200	25
10	16	250	32
16	25**	300	50
25	32	400	75
32	50	450	100
50	75	500	150
75	100		
100	150		

P	5	P	10	P	10	P	20
H	2,2	H	4,5	H	4,5	H	8
H <sub>1</sub>	1,2	H <sub>1</sub>	2,5	H <sub>1</sub>	2,5	H <sub>1</sub>	5

<b>AT3</b>	<b>AT5</b>	<b>AT10</b>	<b>AT20</b>
Standardní šíře (mm)	Standardní šíře (mm)	Standardní šíře (mm)	Standardní šíře (mm)
10	6	16	25
20	10	25	32
25	16	32	50
50	25	50	75
	32	75	100
	50	100	150
	75	150	200
	100		

P	3	P	5	P	10	P	20
H	1,9	H	2,7	H	4,5	H	8
H <sub>1</sub>	1,1	H <sub>1</sub>	1,2	H <sub>1</sub>	2,5	H <sub>1</sub>	5

<b>STD 5M<sup>®</sup></b>	<b>STD 8M<sup>®</sup></b>
Standardní šíře (mm)	Standardní šíře (mm)
10	10
15	12
25	15
50	20
	30
	50
	85

P	5	P	8
H	3,4	H	5,1
H <sub>1</sub>	1,91	H <sub>1</sub>	3,05

<b>TT 5</b>
Standardní šíře (mm)
10 ocel
10 kevlar modrý

P	5
H	3 2,8
H <sub>1</sub>	1,2 1,2

<b>P1</b>	<b>P2</b>	<b>P3</b>	<b>P4</b>
Standardní šíře (mm)	Standardní šíře (mm)	Standardní šíře (mm)	Standardní šíře (mm)
10 modrý	25	25	25
20 bílý 20 kordů	50		50
20 modrý 20 kordů	75		100
20 modrý 24 kordů	100		

H	1	H	2	H	3	H	4
---	---	---	---	---	---	---	---

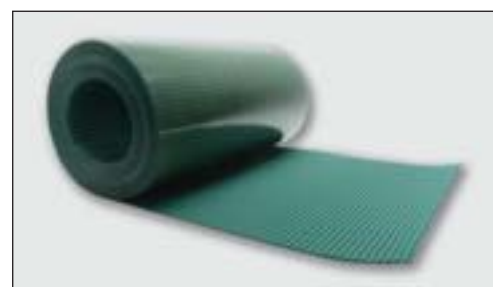

- \* pouze s kevlarovým kordem a redukovaným počtem vláken
- kromě standardní šíře možno dodat jakoukoliv jinou šíř
- \*\* možno dodat také bez technologické drážky
- řemeny se dodávají v provedení černý PU + NFT antistatický





**MEGAFLEX** ozubené řemeny se vyrábějí z termoplastického polyuretanu s vyztuženým podélně spirálovým ocelovým kordem. Tento typ řemene nabízí výborné provozní charakteristiky a možnost extrémně vysokého trakčního zatížení. Jsou speciálně vyrobeny pro přenos síly a pro přepravu s vysokým zatížením v kombinaci s vysokou rychlostí (do 10 000 rpm). Přidání nylonové vrstvy na ozubení již v procesu výroby zvyšuje provozní možnosti ve specifických aplikacích, redukuje hluk při provozu a snižuje koeficient tření cca o 50%. Extra tloušťka polyuretanu na hřbetu zaručuje dostatečnou ochranu vůči agresivním nebo extrémně těžkým materiálům (extra tloušťka pouze na poptávku). Řemeny MEGAFLEX jsou opravdu nekonečné, což jim umožňuje dosahovat skutečně výjimečných parametrů. Řemeny MEGAFLEX je možno vyrobít i v provedení oboustranného ozubení.

#### **MEGAFLEX ŘEMENY SE VYRÁBĚJÍ V DÉLKÁCH OD 1500 MM DO 25400 MM**

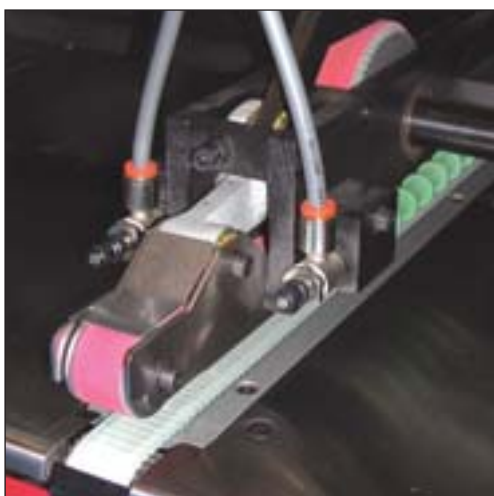

#### **MEGAFLEX**

##### **speciální konstrukce řemenů:**

- vysoce flexibilní kordy (HF)
- NFT (PAZ) nylonová tkanina na ozubení (od délky 1900 mm)
- možnost drážkování, děrování, zdrsňování povrchu a dalších požadavků pro speciální aplikace
- možnost nanášení povrchových úprav na hřbet řemene již při výrobě:
  - PU 85° ShA
  - Tenax 50° ShA
  - Linatex 40° ShA
  - Žlutý PUR 60° ShA
  - Šedý PUR 60° ShA
  - Neopren 70° ShA



**T5 - T10 - T20**

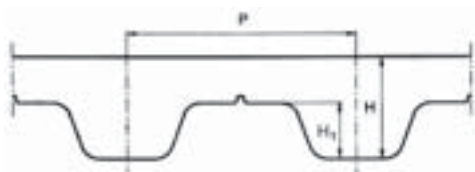

**AT5 - AT10 - AT20**

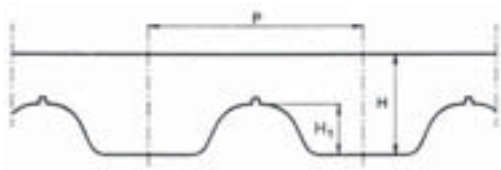

**XL - L - H - XH**

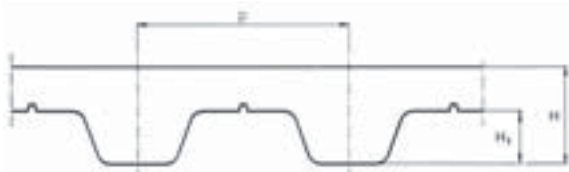

**RPP5 - RPP8 - RPP14**

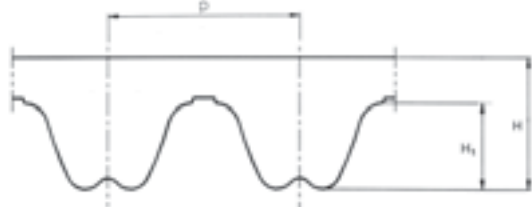

**MTD 8M**

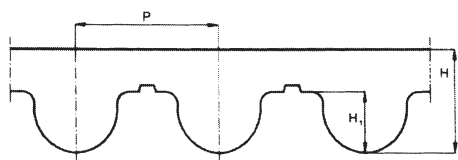

**ATG10**

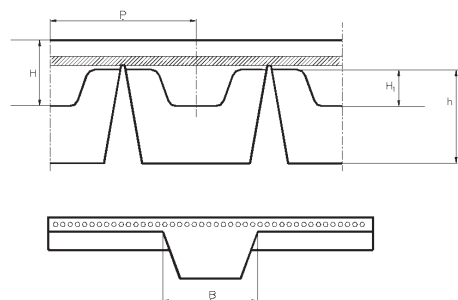

**T5 DL - T10 DL - T20 DL**

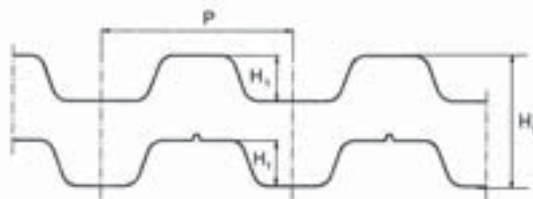

**AT5 DL - AT10 DL - AT20 DL**

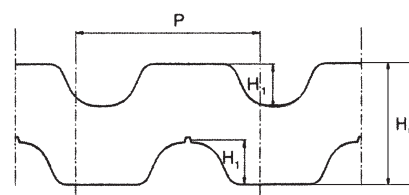

**XL DL - L DL - H DL - XH DL**

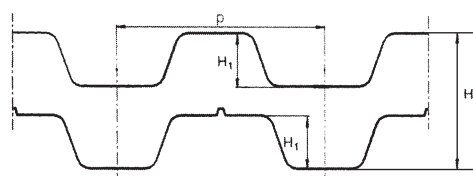

**RPP5 DL - RPP8 DL - RPP14 DL**

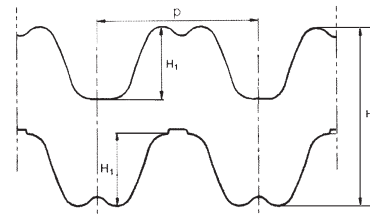

**P2**



<b>P2</b>		<b>ATG10 K13</b>		<b>MTD 8M</b>	
Standardní šíře (mm)		Standardní šíře (mm)		Standardní šíře (mm)	
	25		10		10
	50		16		16
	75		25		25
	100		32		32
	150		50		50
			75		75
			100		100
			150		150
P	2,0	P	10	P	8
		H	4,5	H	5,6
		H <sub>1</sub>	2,5	H <sub>1</sub>	3,4
		B	13		
		h	6,4		



<b>T5/T5DL</b>		<b>T10/T10DL</b>		<b>T20/T20DL</b>	
Standardní šíře (mm)		Standardní šíře (mm)		Standardní šíře (mm)	
	10		10		10
	16		16		16
	25		25		25
	32		32		32
	50		50		50
	75		75		75
	100		100		100
	150		150		150
P	5	P	10	P	20
H	2,2	H	4,5	H	8
H <sub>1</sub>	1,2	H <sub>1</sub>	2,5	H <sub>1</sub>	5
H <sub>t</sub>	3,4	H <sub>t</sub>	7	H <sub>t</sub>	13



AVAFC - PU 85 Shore A, extrudovaný na hřbetu

<b>AT5/AT5DL</b>		<b>AT10/AT10DL</b>		<b>AT20/AT20DL</b>	
Standardní šíře (mm)		Standardní šíře (mm)		Standardní šíře (mm)	
	10		10		10
	16		16		16
	25		25		25
	32		32		32
	50		50		50
	75		75		75
	100		100		100
	150		150		150
P	5	P	10	P	20
H	2,7	H	4,5	H	8
H <sub>1</sub>	1,2	H <sub>1</sub>	2,5	H <sub>1</sub>	5
H <sub>t</sub>	3,9	H <sub>t</sub>	7	H <sub>t</sub>	13



NFT - nylonový potah ozubení, nízké tření a hladina hluku

<b>RPP5/RPP5DL</b>		<b>RPP8/RPP8DL</b>		<b>RPP14/RPP14DL</b>	
Standardní šíře (mm)		Standardní šíře (mm)		Standardní šíře (mm)	
	10		10		10
	15		15		15
	20		20		20
	25		25		25
	50		50		50
	85		85		85
	100		100		100
	150		150		150
P	5	P	8	P	14
H	3,8	H	5,4	H	10
H <sub>1</sub>	2	H <sub>1</sub>	3,2	H <sub>1</sub>	6
H <sub>t</sub>	5,2	H <sub>t</sub>	7,8	H <sub>t</sub>	14,5



Verze s oboustranným ozubením

<b>XL/XLDL</b>		<b>L/LDL</b>		<b>H/HDL</b>		<b>XH/XHDL</b>	
Standardní šíře (mm)		Standardní šíře (mm)		Standardní šíře (mm)		Standardní šíře (mm)	
	12,7		12,7		12,7		12,7
	19,1		19,1		19,1		19,1
	25,4		25,4		25,4		25,4
	38,1		38,1		38,1		38,1
	50,8		50,8		50,8		50,8
	76,2		76,2		76,2		76,2
	101,6		101,6		101,6		101,6
	152,4		152,4		152,4		152,4
P	5,08	P	9,525	P	12,7	P	22,225
H	2,3	H	3,6	H	4,3	H	11,2
H <sub>1</sub>	1,27	H <sub>1</sub>	1,9	H <sub>1</sub>	2,29	H <sub>1</sub>	6,35
H <sub>t</sub>	3,05	H <sub>t</sub>	4,58	H <sub>t</sub>	5,95	H <sub>t</sub>	15,49





**MEGARIB** řemeny se vyrábějí jako polyuretanové řemeny s polyesterovým vláknem, které v sobě kombinují vysokou flexibilitu plochého řemene se schopností klínových řemenů přenášet výkon.

#### Vlastnosti Megarib řemenů:

- rozměrová stabilita
- vysoká pružnost
- malý průměr řemenic
- vysoké rychlosti
- vynikající odolnost vůči olejům, tukům a průmyslovým mazivům

#### Hlavní využití

- potravinářské stroje
- sekačky na trávu
- domácí spotřebiče
- pračky (použití speciálních řemenů)
- elektrické nářadí
- dřevoobráběcí nářadí – stroje a zařízení pro kutily



#### MEGARIB SE

Polyuretanové drážkové řemeny využívající kombinaci polyuretanu a semielastického tažného vlákna. Díky své elasticitě se umísťují do zařízení s pevnou osovou vzdáleností (zejména pračky). Absence napínacího zařízení pomáhá snížit náklady na konstrukci stroje a jeho údržbu. Tyto řemeny jsou k dostání pouze na poptávku.

Standardní řemeny MEGARIB jsou k dispozici v následujících variantách typů a délek:

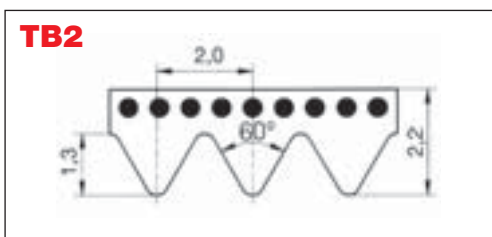
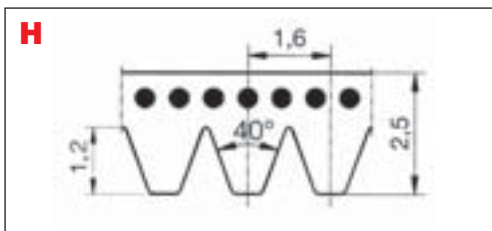
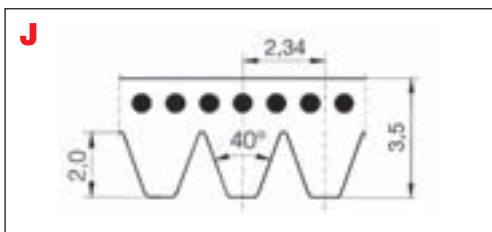

<b>J</b>		<b>H</b>		<b>TB2</b>	
standardní délka		standardní délka		standardní délka	
(mm)	(palce)	(mm)	(mm)	(mm)	(mm)
220	87	178	156		
271	107	217	170		
275	108	223	200		
278	110	227	220		
283	114	229	231		
304	120	295	248		
330	130	330	266		
345	135	340	295		
356	140	375	310		
381	150	389	327		
392	154	400	330		
406	160	485	345		
431	170	507	360		
444	175	588	380		
457	180	602	390		
483	190	609	400		
508	200	650	430		
558	220	768	480		
610	240	935	510		
660	260	1000	526		
681	268	1086	535		
711	280	1120	598		
762	300	1163	630		
864	340	1203	660		
914	360	1240	675		
953	376	1775	725		
1010	398	1976	770		
1086	428		1186		
1120	440				
1163	458				
1202	474				
1239	488				
1268	500				
1397	590				

#### Pozn.:

Kromě rozměrů uvedených v tabulkách se vyrábějí a dodávají různé další typy a rozměry řemenů Poly-V pro použití zejména v domácích elektrospotřebičích. Tyto řemeny Vám dodáme na základě Vaší poptávky.







Zařízení pro montáž unášečů

Všechny **speciální řemeny** mohou být vyrobeny ve standardním provedení nebo s některou z povrchových úprav, podle specifických požadavků zákazníka.

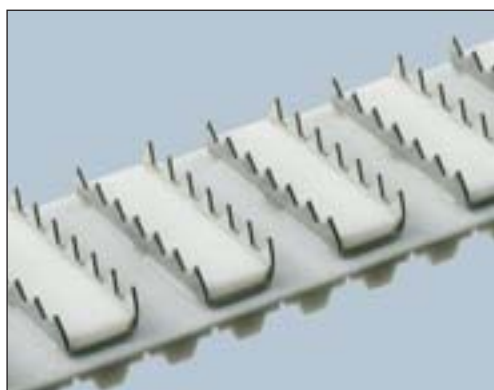

Příklad řemene s navařenými unášeči na hřbetu řemene. K dispozici je velké množství typů unášečů.

Možnost dodatečně vulkanizovaných povrchů na všechny typy řemenů Megadyne:

- Rybí kost
- PU drážkový
- Sylomer (modrý, zelený, hnědý)
- Filc
- Supergrip
- PU transparentní
- Žlutý polyuretan
- Porol
- NBR – Linatril
- Linatex
- Linard – přírodní guma 60 ShA
- Linaplus FG – přírodní guma
- Guma EPMD
- Correx
- Celloflex a mnoho dalších na konkrétní poptávku



Profesionální svařovací zařízení



**Řemenice pro všechny typy odvětří**

v průmyslové výrobě a pro automobily



**Nestandardní řemenice**

vyrobené z kovů nebo plastů



**Provádění povrchových úprav:**

ochrana povrchu a znemožnění koroze



**Standardní a speciální profily řemenic**



# ŘEMENICE/UPÍNACÍ DESKY Ozubené řemenice profilu T

T2.5 06 (rozteč 2.5 mm) pro šířku řemene 6 mm											
	Označení	Nákres	Zuby	Dp	De	Bočnice 0,5	Df	Dm	B1	B2	L
Hliník	16T2,5/12-2	1F	12	9,55	9,03	Bm73	12,0	12	9	8	16
	16T2,5/14-2	1F	14	11,14	10,62	Bm74	15,0	14	9	8	16
	16T2,5/15-2	1F	15	11,94	11,42	Bm74	15,0	15	9	8	16
	16T2,5/16-2	1F	16	12,73	12,21	Bm75	16,0	16	9	8	16
	16T2,5/18-2	AF	18	14,32	13,80	Bm75	16,0	10	10	8	16
	16T2,5/19-2	AF	19	15,12	14,60	Bm0	19,5	10	10	8	16
	16T2,5/20-2	AF	20	15,92	15,40	Bm1	22,0	11	10	8	16
	16T2,5/22-2	AF	22	17,51	16,99	Bm1	22,0	11	10	8	16
	16T2,5/24-2	AF	24	19,10	18,58	Bm1	22,0	12	10	8	16
	16T2,5/25-2	AF	25	19,89	19,37	Bm2	25,0	13	10	8	16
	16T2,5/26-2	AF	26	20,69	20,17	Bm2	25,0	14	10	8	16
	16T2,5/28-2	AF	28	22,28	21,76	Bm2	25,0	14	10	8	16
	16T2,5/30-2	AF	30	23,87	23,35	Bm3	28,0	16	10	8	16
	16T2,5/32-2	AF	32	25,46	24,95	Bm4	32,0	16	10	8	16
	16T2,5/36-2	AF	36	28,65	28,13	Bm5	36,0	20	10	8	16
	16T2,5/40-2	AF	40	31,83	31,31	Bm6	38,0	22	10	8	16
	16T2,5/44-0	A	44	35,01	34,50	-	-	24	10	-	16
16T2,5/48-0	A	48	38,20	37,68	-	-	26	10	-	16	
16T2,5/60-0	A	60	47,75	47,23	-	-	34	10	-	16	

T5 10 (rozteč 5 mm) pro šířku řemene 10 mm											
	Označení	Nákres	Zuby	Dp	De	Bočnice 0,5	Df	Dm	B1	B2	L
Hliník	21T5/10-2	AF	10	15,92	15,09	Bm0	19,5	11	15	11,5	21
	21T5/12-2	AF	12	19,10	18,27	Bm1	22,0	11	15	11,5	21
	21T5/14-2	AF	14	22,28	21,45	Bm2	25,0	14	15	11,5	21
	21T5/15-2	AF	15	23,87	23,04	Bm3	28,0	16	15	11,5	21
	21T5/16-2	AF	16	25,46	24,64	Bm4	32,0	18	15	11,5	21
	21T5/18-2	AF	18	28,65	27,82	Bm4	32,0	20	15	11,5	21
	21T5/19-2	AF	19	30,24	29,41	Bm5	36,0	22	15	11,5	21
	21T5/20-2	AF	20	31,83	31,00	Bm5	36,0	23	15	11,5	21
	21T5/22-2	AF	22	35,01	34,19	Bm6	38,0	24	15	11,5	21
	21T5/24-2	AF	24	38,20	37,37	Bm7	41,0	26	15	11,5	21
	21T5/25-2	AF	25	39,79	38,96	Bm8	47,0	26	15	11,5	21
	21T5/26-2	AF	26	41,38	40,55	Bm8	47,0	26	15	11,5	21
	21T5/27-2	AF	27	42,97	42,14	Bm9	48,0	30	15	11,5	21
	21T5/28-2	AF	28	44,56	43,73	Bm9	48,0	32	15	11,5	21
	21T5/30-2	AF	30	47,75	46,92	Bm10	51,0	34	15	11,5	21
	21T5/32-2	AF	32	50,93	50,10	Bm11	54,0	38	15	11,5	21
	21T5/36-2	AF	36	57,30	56,47	Bm14	63,0	38	15	11,5	21
	21T5/40-2	AF	40	63,66	62,83	Bm15	66,0	40	15	11,5	21
	21T5/42-2	AF	42	66,85	66,02	Bm16	72,0	40	15	11,5	21
	21T5/44-0	A	44	70,03	69,20	-	-	45	15	-	21
21T5/48-0	A	48	76,39	75,57	-	-	50	15	-	21	
21T5/60-0	A	60	95,49	94,67	-	-	65	15	-	21	

Hodnoty Df a Dm se mohou měnit bez předběžného upozornění



T5 16 (rozeč 5 mm) pro šířku řemene 16 mm											
	Označení	Nákres	Zuby	Dp	De	Bočnice 0,5	Df	Dm	B1	B2	L
Hliník	27T5/10-2	AF	10	15,92	15,09	Bm0	19,5	11	21	17,5	27
	27T5/12-2	AF	12	19,10	18,27	Bm1	22,0	11	21	17,5	27
	27T5/14-2	AF	14	22,28	21,45	Bm2	25,0	14	21	17,5	27
	27T5/15-2	AF	15	23,87	23,04	Bm3	28,0	16	21	17,5	27
	27T5/16-2	AF	16	25,46	24,64	Bm4	32,0	18	21	17,5	27
	27T5/18-2	AF	18	28,65	27,82	Bm4	32,0	20	21	17,5	27
	27T5/19-2	AF	19	30,24	29,41	Bm5	36,0	22	21	17,5	27
	27T5/20-2	AF	20	31,83	31,00	Bm5	36,0	23	21	17,5	27
	27T5/22-2	AF	22	35,01	34,19	Bm6	38,0	24	21	17,5	27
	27T5/24-2	AF	24	38,20	37,37	Bm7	41,0	26	21	17,5	27
	27T5/25-2	AF	25	39,79	38,96	Bm8	47,0	26	21	17,5	27
	27T5/26-2	AF	26	41,38	40,55	Bm8	47,0	26	21	17,5	27
	27T5/27-2	AF	27	42,97	42,14	Bm9	48,0	30	21	17,5	27
	27T5/28-2	AF	28	44,56	43,73	Bm9	48,0	32	21	17,5	27
	27T5/30-2	AF	30	47,75	46,92	Bm10	51,0	34	21	17,5	27
	27T5/32-2	AF	32	50,93	50,10	Bm11	54,0	38	21	17,5	27
	27T5/36-2	AF	36	57,30	56,47	Bm14	63,0	38	21	17,5	27
	27T5/40-2	AF	40	63,66	62,83	Bm15	66,0	40	21	17,5	27
	27T5/42-2	AF	42	66,85	66,02	Bm16	72,0	40	21	17,5	27
	27T5/44-0	A	44	70,03	69,20	-	-	45	21	-	27
27T5/48-0	A	48	76,39	75,57	-	-	50	21	-	27	
27T5/60-0	A	60	95,49	94,67	-	-	65	21	-	27	

T5 25 (rozeč 5 mm) pro šířku řemene 25 mm											
	Označení	Nákres	Zuby	Dp	De	Bočnice 0,5	Df	Dm	B1	B2	L
Hliník	36T5/10-2	AF	10	15,92	15,09	Bm0	19,5	11	30	26,5	36
	36T5/12-2	AF	12	19,10	18,27	Bm1	22,0	11	30	26,5	36
	36T5/14-2	AF	14	22,28	21,45	Bm2	25,0	14	30	26,5	36
	36T5/15-2	AF	15	23,87	23,04	Bm3	28,0	16	30	26,5	36
	36T5/16-2	AF	16	25,46	24,64	Bm4	32,0	18	30	26,5	36
	36T5/18-2	AF	18	28,65	27,82	Bm4	32,0	20	30	26,5	36
	36T5/19-2	AF	19	30,24	29,41	Bm5	36,0	22	30	26,5	36
	36T5/20-2	AF	20	31,83	31,00	Bm5	36,0	23	30	26,5	36
	36T5/22-2	AF	22	35,01	34,19	Bm6	38,0	24	30	26,5	36
	36T5/24-2	AF	24	38,20	37,37	Bm7	41,0	26	30	26,5	36
	36T5/25-2	AF	25	39,79	38,96	Bm8	47,0	26	30	26,5	36
	36T5/26-2	AF	26	41,38	40,55	Bm8	47,0	26	30	26,5	36
	36T5/27-2	AF	27	42,97	42,14	Bm9	48,0	30	30	26,5	36
	36T5/28-2	AF	28	44,56	43,73	Bm9	48,0	32	30	26,5	36
	36T5/30-2	AF	30	47,75	46,92	Bm10	51,0	34	30	26,5	36
	36T5/32-2	AF	32	50,93	50,10	Bm11	54,0	38	30	26,5	36
	36T5/36-2	AF	36	57,30	56,47	Bm14	63,0	38	30	26,5	36
	36T5/40-2	AF	40	63,66	62,83	Bm15	66,0	40	30	26,5	36
	36T5/42-2	AF	42	66,85	66,02	Bm16	72,0	40	30	26,5	36
	36T5/44-0	A	44	70,03	69,20	-	-	45	30	-	36
36T5/48-0	A	48	76,39	75,57	-	-	50	30	-	36	
36T5/60-0	A	60	95,49	94,67	-	-	65	30	-	36	

Hodnoty Df a Dm se mohou měnit bez předběžného upozornění

# ŘEMENICE/UPÍNACÍ DESKY Ozubené řemenice profilu T

T10 16 (rozteč 10 mm) pro šířku řemene 16 mm											
	Označení	Nákres	Zuby	Dp	De	Bočnice 0,5	Df	Dm	B1	B2	L
Hlítník	31T10/12-2	AF	12	38,20	36,35	Bm7	41	28	21	17,5	31
	31T10/14-2	AF	14	44,56	42,71	Bm9	48	32	21	17,5	31
	31T10/15-2	AF	15	47,75	45,90	Bm10	51	32	21	17,5	31
	31T10/16-2	AF	16	50,93	49,08	Bm11	54	35	21	17,5	31
	31T10/18-2	AF	18	57,30	55,45	Bm13	60	40	21	17,5	31
	31T10/19-2	AF	19	60,48	58,63	Bm15	66	44	21	17,5	31
	31T10/20-2	AF	20	63,66	61,81	Bm15	66	46	21	17,5	31
	31T10/22-2	AF	22	70,03	68,18	Bm17	75	52	21	17,5	31
	31T10/24-2	AF	24	76,39	74,55	Bm19	83	58	21	17,5	31
	31T10/25-2	AF	25	79,58	77,73	Bm19	83	60	21	17,5	31
	31T10/26-2	AF	26	82,76	80,91	Bm20	87	60	21	17,5	31
	31T10/27-2	AF	27	85,94	84,10	Bm21	91	60	21	17,5	31
	31T10/28-2	AF	28	89,13	87,28	Bm22	93	60	21	17,5	31
	31T10/30-2	AF	30	95,49	93,65	Bm23	97	60	21	17,5	31
	31T10/32-2	AF	32	101,86	100,01	Bm25	106	65	21	17,5	31
	31T10/36-2	AF	36	114,59	112,74	Bm28	119	70	21	17,5	31
	31T10/40-2	AF	40	127,32	125,48	Bm31	131	80	21	17,5	31
31T10/44-0	A	44	140,06	138,21	-	-	88	21	-	31	
31T10/48-0	A	48	152,79	150,94	-	-	95	21	-	31	
31T10/60-0	A	60	190,99	189,14	-	-	110	21	-	31	

T10 25 (rozteč 10 mm) pro šířku řemene 25 mm											
	Označení	Nákres	Zuby	Dp	De	Bočnice 0,5	Df	Dm	B1	B2	L
Hlítník	40T10/12-2	AF	12	38,20	36,35	Bm7	41	28	30	26,5	40
	40T10/14-2	AF	14	44,56	42,71	Bm9	48	32	30	26,5	40
	40T10/15-2	AF	15	47,75	45,90	Bm10	51	32	30	26,5	40
	40T10/16-2	AF	16	50,93	49,08	Bm11	54	35	30	26,5	40
	40T10/18-2	AF	18	57,30	55,45	Bm13	60	40	30	26,5	40
	40T10/19-2	AF	19	60,48	58,63	Bm15	66	44	30	26,5	40
	40T10/20-2	AF	20	63,66	61,81	Bm15	66	46	30	26,5	40
	40T10/22-2	AF	22	70,03	68,18	Bm17	75	52	30	26,5	40
	40T10/24-2	AF	24	76,39	74,55	Bm19	83	58	30	26,5	40
	40T10/25-2	AF	25	79,58	77,73	Bm19	83	60	30	26,5	40
	40T10/26-2	AF	26	82,76	80,91	Bm20	87	60	30	26,5	40
	40T10/27-2	AF	27	85,94	84,10	Bm21	91	60	30	26,5	40
	40T10/28-2	AF	28	89,13	87,28	Bm22	93	60	30	26,5	40
	40T10/30-2	AF	30	95,49	93,65	Bm23	97	60	30	26,5	40
	40T10/32-2	AF	32	101,86	100,01	Bm25	106	65	30	26,5	40
	40T10/36-2	AF	36	114,59	112,74	Bm28	119	70	30	26,5	40
	40T10/40-2	AF	40	127,32	125,48	Bm31	131	80	30	26,5	40
40T10/44-0	A	44	140,06	138,21	-	-	88	30	-	40	
40T10/48-0	A	48	152,79	150,94	-	-	95	30	-	40	
40T10/60-0	A	60	190,99	189,14	-	-	110	30	-	40	

T10 32 (10 mm rozteč) pro šířku řemene 32 mm											
	Označení	Nákres	Zuby	Dp	De	Bočnice 0,5	Df	Dm	B1	B2	L
Hlítník	47T10/18-2	AF	18	57,30	55,45	Bm13	60	40	37	33,5	47
	47T10/19-2	AF	19	60,48	58,63	Bm15	66	44	37	33,5	47
	47T10/20-2	AF	20	63,66	61,81	Bm15	66	46	37	33,5	47
	47T10/22-2	AF	22	70,03	68,18	Bm17	75	52	37	33,5	47
	47T10/24-2	AF	24	76,39	74,55	Bm19	83	58	37	33,5	47
	47T10/25-2	AF	25	79,58	77,73	Bm19	83	60	37	33,5	47
	47T10/26-2	AF	26	82,76	80,91	Bm20	87	60	37	33,5	47
	47T10/27-2	AF	27	85,94	84,10	Bm21	91	60	37	33,5	47
	47T10/28-2	AF	28	89,13	87,28	Bm22	93	60	37	33,5	47
	47T10/30-2	AF	30	95,49	93,65	Bm23	97	60	37	33,5	47
	47T10/32-2	AF	32	101,86	100,01	Bm25	106	65	37	33,5	47
	47T10/36-2	AF	36	114,59	112,74	Bm28	119	70	37	33,5	47
	47T10/40-2	AF	40	127,32	125,48	Bm31	131	80	37	33,5	47
	47T10/44-0	A	44	140,06	138,21	-	-	88	37	-	47
	47T10/48-0	A	48	152,79	150,94	-	-	95	37	-	47
47T10/60-0	A	60	190,99	189,14	-	-	110	37	-	47	

Hodnoty Df a Dm se mohou měnit bez předběžného upozornění

T10 50 (rozteč 10 mm) pro šířku řemene 50 mm											
	Označení	Nákres	Zuby	Dp	De	Bočnice 0,5	Df	Dm	B1	B2	L
Hliník	66T10/18-2	AF	18	57,30	55,45	Bm13	60	40	56	52,5	66
	66T10/19-2	AF	19	60,48	58,63	Bm15	66	44	56	52,5	66
	66T10/20-2	AF	20	63,66	61,81	Bm15	66	46	56	52,5	66
	66T10/22-2	AF	22	70,03	68,18	Bm17	75	52	56	52,5	66
	66T10/24-2	AF	24	76,39	74,55	Bm19	83	58	56	52,5	66
	66T10/25-2	AF	25	79,58	77,73	Bm19	83	60	56	52,5	66
	66T10/26-2	AF	26	82,76	80,91	Bm20	87	60	56	52,5	66
	66T10/27-2	AF	27	85,94	84,10	Bm21	91	60	56	52,5	66
	66T10/28-2	AF	28	89,13	87,28	Bm22	93	60	56	52,5	66
	66T10/30-2	AF	30	95,49	93,65	Bm23	97	60	56	52,5	66
	66T10/32-2	AF	32	101,86	100,01	Bm25	106	65	56	52,5	66
	66T10/36-2	AF	36	114,59	112,74	Bm28	119	70	56	52,5	66
	66T10/40-2	AF	40	127,32	125,48	Bm31	131	80	56	52,5	66
	66T10/44-0	A	44	140,06	138,21	-	-	88	56	-	66
	66T10/48-0	A	48	152,79	150,94	-	-	95	56	-	66
66T10/60-0	A	60	190,99	189,14	-	-	110	56	-	66	

T20 32 (rozteč 20 mm) pro šířku řemene 32 mm											
	Označení	Nákres	Zuby	Dp	De	Bočnice 0,5	Df	Dm	B1	B2	L
Hliník	53T20/18-2	AF	18	114,59	111,73	Bm92	119	80	42	37	53
	53T20/20-2	AF	20	127,32	124,47	Bm43	138	90	42	37	53
	53T20/22-2	AF	22	140,06	137,20	Bm45	145	90	42	37	53
	53T20/24-2	AF	24	152,79	149,93	Bm47	162	95	42	37	53
	53T20/25-2	AF	25	159,15	156,30	Bm48	168	95	42	37	53
	53T20/30-2	AF	30	190,99	188,13	Bm52	200	110	42	37	53
	53T20/32-0	A	32	203,72	200,86	-	-	110	42	-	53
	53T20/36-0	A	36	229,18	226,33	-	-	110	42	-	53
	53T20/40-0	A	40	254,65	251,80	-	-	110	42	-	53
	53T20/48-0	A	48	305,58	302,73	-	-	130	42	-	53
	53T20/60-0	A	60	381,97	379,12	-	-	130	42	-	53

T20 50 (rozteč 20 mm) pro šířku řemene 50 mm											
	Označení	Nákres	Zuby	Dp	De	Bočnice 0,5	Df	Dm	B1	B2	L
Hliník	71T20/18-2	AF	18	114,59	111,73	Bm92	119	80	60	55	71
	71T20/20-2	AF	20	127,32	124,47	Bm43	138	90	60	55	71
	71T20/22-2	AF	22	140,06	137,20	Bm45	145	90	60	55	71
	71T20/24-2	AF	24	152,79	149,93	Bm47	162	95	60	55	71
	71T20/25-2	AF	25	159,15	156,30	Bm48	168	95	60	55	71
	71T20/30-2	AF	30	190,99	188,13	Bm52	200	110	60	55	71
	71T20/32-0	A	32	203,72	200,86	-	-	110	60	-	71
	71T20/36-0	A	36	229,18	226,33	-	-	110	60	-	71
	71T20/40-0	A	40	254,65	251,80	-	-	110	60	-	71
	71T20/48-0	A	48	305,58	302,73	-	-	130	60	-	71
	71T20/60-0	A	60	381,97	379,12	-	-	130	60	-	71

Hodnoty Df a Dm se mohou měnit bez předběžného upozornění

# ŘEMENICE/UPÍNACÍ DESKY Ozubené řemenice profilu T

T20 75 (20 mm rozteč ) pro šířku řemene 75 mm											
	Označení	Nákres	Zuby	Dp	De	Bočnice 0,5	Df	Dm	B1	B2	L
Hliník	106T20/18-2	AF	18	114,59	111,73	Bm92	119	80	85	80	106
	106T20/20-2	AF	20	127,32	124,47	Bm43	138	90	85	80	106
	106T20/22-2	AF	22	140,06	137,20	Bm45	145	90	85	80	106
	106T20/24-2	AF	24	152,79	149,93	Bm47	162	95	85	80	106
	106T20/25-2	AF	25	159,15	156,30	Bm48	168	95	85	80	106
	106T20/30-2	AF	30	190,99	188,13	Bm52	200	110	85	80	106
	106T20/32-0	A	32	203,72	200,86	-	-	110	85	-	106
	106T20/36-0	A	36	229,18	226,33	-	-	110	85	-	106
	106T20/40-0	A	40	254,65	251,80	-	-	110	85	-	106
	106T20/48-0	A	48	305,58	302,73	-	-	130	85	-	106
106T20/60-0	A	60	381,97	379,12	-	-	130	85	-	106	

T 20 100 (20 mm rozteč ) pro šířku řemene 100 mm											
	Označení	Nákres	Zuby	Dp	De	Bočnice 0,5	Df	Dm	B1	B2	L
Hliník	123T20/18-2	AF	18	114,59	111,73	Bm92	119	80	110	105	123
	123T20/20-2	AF	20	127,32	124,47	Bm43	138	90	110	105	123
	123T20/22-2	AF	22	140,06	137,20	Bm45	145	90	110	105	123
	123T20/24-2	AF	24	152,79	149,93	Bm47	162	95	110	105	123
	123T20/25-2	AF	25	159,15	156,30	Bm48	168	95	110	105	123
	123T20/30-2	AF	30	190,99	188,13	Bm52	200	110	110	105	123
	123T20/32-0	A	32	203,72	200,86	-	-	110	110	-	123
	123T20/36-0	A	36	229,18	226,33	-	-	110	110	-	123
	123T20/40-0	A	40	254,65	251,80	-	-	110	110	-	123
	123T20/48-0	A	48	305,58	302,73	-	-	130	110	-	123
123T20/60-0	A	60	381,97	379,12	-	-	130	110	-	123	

Hodnoty Df a Dm se mohou měnit bez předběžného upozornění



AT5 10 (rozteč 5 mm rozteč) pro šířku řemene 10 mm											
	Označení	Nákres	Zuby	Dp	De	Bočnice 0,5	Df	Dm	B1	B2	L
Hliník	21AT5/12-2	AF	12	19,10	17,87	Bm1	22	11	15	11,5	21
	21AT5/14-2	AF	14	22,28	21,05	Bm2	25	14	15	11,5	21
	21AT5/15-2	AF	15	23,87	22,64	Bm3	28	16	15	11,5	21
	21AT5/16-2	AF	16	25,46	24,24	Bm4	32	18	15	11,5	21
	21AT5/18-2	AF	18	28,65	27,42	Bm4	32	20	15	11,5	21
	21AT5/19-2	AF	19	30,24	29,01	Bm5	36	22	15	11,5	21
	21AT5/20-2	AF	20	31,83	30,60	Bm5	36	23	15	11,5	21
	21AT5/22-2	AF	22	35,01	33,79	Bm6	38	24	15	11,5	21
	21AT5/24-2	AF	24	38,20	36,97	Bm7	41	26	15	11,5	21
	21AT5/25-2	AF	25	39,79	38,56	Bm8	47	26	15	11,5	21
	21AT5/26-2	AF	26	41,38	40,15	Bm8	47	26	15	11,5	21
	21AT5/27-2	AF	27	42,97	41,74	Bm9	48	30	15	11,5	21
	21AT5/28-2	AF	28	44,56	43,33	Bm9	48	32	15	11,5	21
	21AT5/30-2	AF	30	47,75	46,52	Bm10	51	34	15	11,5	21
	21AT5/32-2	AF	32	50,93	49,70	Bm11	54	38	15	11,5	21
	21AT5/36-2	AF	36	57,30	56,07	Bm14	63	38	15	11,5	21
	21AT5/40-2	AF	40	63,66	62,43	Bm15	66	40	15	11,5	21
	21AT5/42-2	AF	42	66,85	65,62	Bm16	72	40	15	11,5	21
	21AT5/44-0	A	44	70,03	68,80	-	-	45	15	-	21
	21AT5/48-0	A	48	76,39	75,17	-	-	50	15	-	21
21AT5/60-0	A	60	95,49	94,27	-	-	65	15	-	21	

AT5 16 (rozteč 5 mm rozteč) pro šířku řemene 16 mm											
	Označení	Nákres	Zuby	Dp	De	Bočnice 0,5	Df	Dm	B1	B2	L
Hliník	27AT5/12-2	AF	12	19,10	17,87	Bm1	22	11	21	17,5	27
	27AT5/14-2	AF	14	22,28	21,05	Bm2	25	14	21	17,5	27
	27AT5/15-2	AF	15	23,87	22,64	Bm3	28	16	21	17,5	27
	27AT5/16-2	AF	16	25,46	24,24	Bm4	32	18	21	17,5	27
	27AT5/18-2	AF	18	28,65	27,42	Bm4	32	20	21	17,5	27
	27AT5/19-2	AF	19	30,24	29,01	Bm5	36	22	21	17,5	27
	27AT5/20-2	AF	20	31,83	30,60	Bm5	36	23	21	17,5	27
	27AT5/22-2	AF	22	35,01	33,79	Bm6	38	24	21	17,5	27
	27AT5/24-2	AF	24	38,20	36,97	Bm7	41	26	21	17,5	27
	27AT5/25-2	AF	25	39,79	38,56	Bm8	47	26	21	17,5	27
	27AT5/26-2	AF	26	41,38	40,15	Bm8	47	26	21	17,5	27
	27AT5/27-2	AF	27	42,97	41,74	Bm9	48	30	21	17,5	27
	27AT5/28-2	AF	28	44,56	43,33	Bm9	48	32	21	17,5	27
	27AT5/30-2	AF	30	47,75	46,52	Bm10	51	34	21	17,5	27
	27AT5/32-2	AF	32	50,93	49,70	Bm11	54	38	21	17,5	27
	27AT5/36-2	AF	36	57,30	56,07	Bm14	63	38	21	17,5	27
	27AT5/40-2	AF	40	63,66	62,43	Bm15	66	40	21	17,5	27
	27AT5/42-2	AF	42	66,85	65,62	Bm16	72	40	21	17,5	27
	27AT5/44-0	A	44	70,03	68,80	-	-	45	21	-	27
	27AT5/48-0	A	48	76,39	75,17	-	-	50	21	-	27
27AT5/60-0	A	60	95,49	94,27	-	-	65	21	-	27	

Hodnoty Df a Dm se mohou měnit bez předběžného upozornění

# ŘEMENICE/UPÍNACÍ DESKY Ozubené řemenice profilu AT

AT5 16 (rozteč 5 mm rozteč) pro šířku řemene 16 mm											
	Označení	Nákres	Zuby	Dp	De	Bočnice 0,5	Df	Dm	B1	B2	L
Hliník	36AT5/12-2	AF	12	19,10	17,87	Bm1	22	11	30	26,5	36
	36AT5/14-2	AF	14	22,28	21,05	Bm2	25	14	30	26,5	36
	36AT5/15-2	AF	15	23,87	22,64	Bm3	28	16	30	26,5	36
	36AT5/16-2	AF	16	25,46	24,24	Bm4	32	18	30	26,5	36
	36AT5/18-2	AF	18	28,65	27,42	Bm4	32	20	30	26,5	36
	36AT5/19-2	AF	19	30,24	29,01	Bm5	36	22	30	26,5	36
	36AT5/20-2	AF	20	31,83	30,60	Bm5	36	23	30	26,5	36
	36AT5/22-2	AF	22	35,01	33,79	Bm6	38	24	30	26,5	36
	36AT5/24-2	AF	24	38,20	36,97	Bm7	41	26	30	26,5	36
	36AT5/25-2	AF	25	39,79	38,56	Bm8	47	26	30	26,5	36
	36AT5/26-2	AF	26	41,38	40,15	Bm8	47	26	30	26,5	36
	36AT5/27-2	AF	27	42,97	41,74	Bm9	48	30	30	26,5	36
	36AT5/28-2	AF	28	44,56	43,33	Bm9	48	32	30	26,5	36
	36AT5/30-2	AF	30	47,75	46,52	Bm10	51	34	30	26,5	36
	36AT5/32-2	AF	32	50,93	49,70	Bm11	54	38	30	26,5	36
	36AT5/36-2	AF	36	57,30	56,07	Bm14	63	38	30	26,5	36
36AT5/40-2	AF	40	63,66	62,43	Bm15	66	40	30	26,5	36	
36AT5/42-2	AF	42	66,85	65,62	Bm16	72	40	30	26,5	36	
36AT5/44-0	A	44	70,03	68,80	-	-	45	30	-	36	
36AT5/48-0	A	48	76,39	75,17	-	-	50	30	-	36	
36AT5/60-0	A	60	95,49	94,27	-	-	65	30	-	36	

AT5 16 rozteč (5 mm rozteč) pro šířku řemene 16 mm											
	Označení	Nákres	Zuby	Dp	De	Bočnice 0,5	Df	Dm	B1	B2	L
Hliník	31AT10/15-2	AF	15	47,75	45,90	Bm10	51	32	21	17,5	31
	31AT10/16-2	AF	16	50,93	49,08	Bm11	54	35	21	17,5	31
	31AT10/18-2	AF	18	57,30	55,45	Bm13	60	40	21	17,5	31
	31AT10/19-2	AF	19	60,48	58,63	Bm15	66	44	21	17,5	31
	31AT10/20-2	AF	20	63,66	61,81	Bm15	66	46	21	17,5	31
	31AT10/22-2	AF	22	70,03	68,18	Bm17	75	52	21	17,5	31
	31AT10/24-2	AF	24	76,39	74,55	Bm19	83	58	21	17,5	31
	31AT10/25-2	AF	25	79,58	77,73	Bm19	83	60	21	17,5	31
	31AT10/26-2	AF	26	82,76	80,91	Bm20	87	60	21	17,5	31
	31AT10/27-2	AF	27	85,94	84,10	Bm21	91	60	21	17,5	31
	31AT10/28-2	AF	28	89,13	87,28	Bm22	93	60	21	17,5	31
	31AT10/30-2	AF	30	95,49	93,65	Bm23	97	60	21	17,5	31
	31AT10/32-2	AF	32	101,86	100,01	Bm25	106	65	21	17,5	31
	31AT10/36-2	AF	36	114,59	112,74	Bm28	119	70	21	17,5	31
	31AT10/40-2	AF	40	127,32	125,48	Bm31	131	80	21	17,5	31
	31AT10/44-0	A	44	140,06	138,21	-	-	88	21	-	31
31AT10/48-0	A	48	152,79	150,94	-	-	95	21	-	31	
31AT10/60-0	A	60	190,99	189,14	-	-	110	21	-	31	

AT5 16 (rozteč 5 mm rozteč) pro šířku řemene 16 mm											
	Označení	Nákres	Zuby	Dp	De	Bočnice 0,5	Df	Dm	B1	B2	L
Hliník	40AT10/15-2	AF	15	47,75	45,90	Bm10	51	32	30	26,5	40
	40AT10/16-2	AF	16	50,93	49,08	Bm11	54	35	30	26,5	40
	40AT10/18-2	AF	18	57,30	55,45	Bm13	60	40	30	26,5	40
	40AT10/19-2	AF	19	60,48	58,63	Bm15	66	44	30	26,5	40
	40AT10/20-2	AF	20	63,66	61,81	Bm15	66	46	30	26,5	40
	40AT10/22-2	AF	22	70,03	68,18	Bm17	75	52	30	26,5	40
	40AT10/24-2	AF	24	76,39	74,55	Bm19	83	58	30	26,5	40
	40AT10/25-2	AF	25	79,58	77,73	Bm19	83	60	30	26,5	40
	40AT10/26-2	AF	26	82,76	80,91	Bm20	87	60	30	26,5	40
	40AT10/27-2	AF	27	85,94	84,10	Bm21	91	60	30	26,5	40
	40AT10/28-2	AF	28	89,13	87,28	Bm22	93	60	30	26,5	40
	40AT10/30-2	AF	30	95,49	93,65	Bm23	97	60	30	26,5	40
	40AT10/32-2	AF	32	101,86	100,01	Bm25	106	65	30	26,5	40
	40AT10/36-2	AF	36	114,59	112,74	Bm28	119	70	30	26,5	40
	40AT10/40-2	AF	40	127,32	125,48	Bm31	131	80	30	26,5	40
	40AT10/44-0	A	44	140,06	138,21	-	-	88	30	-	40
40AT10/48-0	A	48	152,79	150,94	-	-	95	30	-	40	
40AT10/60-0	A	60	190,99	189,14	-	-	110	30	-	40	

Hodnoty Df a Dm se mohou měnit bez předběžného upozornění

AT10 32 (rozteč 10 mm) pro šířku řemene 32 mm											
	Označení	Nákres	Zuby	Dp	De	Bočnice 0,5	Df	Dm	B1	B2	L
Hliník	47AT10/18-2	AF	18	57,30	55,45	Bm13	60	40	37	33,5	47
	47AT10/19-2	AF	19	60,48	58,63	Bm15	66	44	37	33,5	47
	47AT10/20-2	AF	20	63,66	61,81	Bm15	66	46	37	33,5	47
	47AT10/22-2	AF	22	70,03	68,18	Bm17	75	52	37	33,5	47
	47AT10/24-2	AF	24	76,39	74,55	Bm19	83	58	37	33,5	47
	47AT10/25-2	AF	25	79,58	77,73	Bm19	83	60	37	33,5	47
	47AT10/26-2	AF	26	82,76	80,91	Bm20	87	60	37	33,5	47
	47AT10/27-2	AF	27	85,94	84,10	Bm21	91	60	37	33,5	47
	47AT10/28-2	AF	28	89,13	87,28	Bm22	93	60	37	33,5	47
	47AT10/30-2	AF	30	95,49	93,65	Bm23	97	60	37	33,5	47
	47AT10/32-2	AF	32	101,86	100,01	Bm25	106	65	37	33,5	47
	47AT10/36-2	AF	36	114,59	112,74	Bm28	119	70	37	33,5	47
	47AT10/40-2	AF	40	127,32	125,48	Bm31	131	80	37	33,5	47
	47AT10/44-0	A	44	140,06	138,21	-	-	88	37	-	47
	47AT10/48-0	A	48	152,79	150,94	-	-	95	37	-	47
47AT10/60-0	A	60	190,99	189,14	-	-	110	37	-	47	

AT10 50 (rozteč 10 mm) pro šířku řemene 50 mm											
	Označení	Nákres	Zuby	Dp	De	Bočnice 0,5	Df	Dm	B1	B2	L
Hliník	66AT10/18-2	AF	18	57,30	55,45	Bm13	60	40	56	52	66
	66AT10/19-2	AF	19	60,48	58,63	Bm15	66	44	56	52	66
	66AT10/20-2	AF	20	63,66	61,81	Bm15	66	46	56	52	66
	66AT10/22-2	AF	22	70,03	68,18	Bm17	75	52	56	52	66
	66AT10/24-2	AF	24	76,39	74,55	Bm19	83	58	56	52	66
	66AT10/25-2	AF	25	79,58	77,73	Bm19	83	60	56	52	66
	66AT10/26-2	AF	26	82,76	80,91	Bm20	87	60	56	52	66
	66AT10/27-2	AF	27	85,94	84,10	Bm21	91	60	56	52	66
	66AT10/28-2	AF	28	89,13	87,28	Bm22	93	60	56	52	66
	66AT10/30-2	AF	30	95,49	93,65	Bm23	97	60	56	52	66
	66AT10/32-2	AF	32	101,86	100,01	Bm25	106	65	56	52	66
	66AT10/36-2	AF	36	114,59	112,74	Bm28	119	70	56	52	66
	66AT10/40-2	AF	40	127,32	125,48	Bm31	131	80	56	52	66
	66AT10/44-0	A	44	140,06	138,21	-	-	88	56	-	66
	66AT10/48-0	A	48	152,79	150,94	-	-	95	56	-	66
66AT10/60-0	A	60	190,99	189,14	-	-	110	56	-	66	

AT20 32 (rozteč 20 mm) pro šířku řemene 32 mm											
	Označení	Nákres	Zuby	Dp	De	Bočnice 0,5	Df	Dm	B1	B2	L
Hliník	53AT20/18-2	AF	18	114,59	111,73	Bm92	119	80	42	37	53
	53AT20/20-2	AF	20	127,32	124,47	Bm43	138	90	42	37	53
	53AT20/22-2	AF	22	140,06	137,20	Bm45	145	90	42	37	53
	53AT20/24-2	AF	24	152,79	149,93	Bm47	162	95	42	37	53
	53AT20/25-2	AF	25	159,15	156,30	Bm48	168	95	42	37	53
	53AT20/30-2	AF	30	190,99	188,13	Bm52	200	110	42	37	53
	53AT20/32-0	A	32	203,72	200,86	-	-	110	42	-	53
	53AT20/36-0	A	36	229,18	226,33	-	-	110	42	-	53
	53AT20/40-0	A	40	254,65	251,80	-	-	110	42	-	53
	53AT20/48-0	A	48	305,58	302,73	-	-	130	42	-	53
	53AT20/60-0	A	60	381,97	379,12	-	-	130	42	-	53

Hodnoty Df a Dm se mohou měnit bez předběžného upozornění

# ŘEMENICE/UPÍNACÍ DESKY Ozubené řemenice profilu AT

AT20 50 rozteč (20 mm) pro šířku řemene 50 mm											
	Označení	Nákres	Zuby	Dp	De	Bočnice 0,5	Df	Dm	B1	B2	L
Hliník	71AT20/18-2	AF	18	114,59	111,73	Bm92	119	80	60	55	71
	71AT20/20-2	AF	20	127,32	124,47	Bm43	138	90	60	55	71
	71AT20/22-2	AF	22	140,06	137,20	Bm45	145	90	60	55	71
	71AT20/24-2	AF	24	152,79	149,93	Bm47	162	95	60	55	71
	71AT20/25-2	AF	25	159,15	156,30	Bm48	168	95	60	55	71
	71AT20/30-2	AF	30	190,99	188,13	Bm52	200	110	60	55	71
	71AT20/32-0	A	32	203,72	200,86	-	-	110	60	-	71
	71AT20/36-0	A	36	229,18	226,33	-	-	110	60	-	71
	71AT20/40-0	A	40	254,65	251,80	-	-	110	60	-	71
	71AT20/48-0	A	48	305,58	302,73	-	-	130	60	-	71
71AT20/60-0	A	60	381,97	379,12	-	-	130	60	-	71	

AT20 75 (rozteč 20 mm) pro šířku řemene 75 mm											
	Označení	Nákres	Zuby	Dp	De	Bočnice 0,5	Df	Dm	B1	B2	L
Hliník	106AT20/18-2	AF	18	114,59	111,73	Bm92	119	80	85	80	106
	106AT20/20-2	AF	20	127,32	124,47	Bm43	138	90	85	80	106
	106AT20/22-2	AF	22	140,06	137,20	Bm45	145	90	85	80	106
	106AT20/24-2	AF	24	152,79	149,93	Bm47	162	95	85	80	106
	106AT20/25-2	AF	25	159,15	156,30	Bm48	168	95	85	80	106
	106AT20/30-2	AF	30	190,99	188,13	Bm52	200	110	85	80	106
	106AT20/32-0	A	32	203,72	200,86	-	-	110	85	-	106
	106AT20/36-0	A	36	229,18	226,33	-	-	110	85	-	106
	106AT20/40-0	A	40	254,65	251,80	-	-	110	85	-	106
	106AT20/48-0	A	48	305,58	302,73	-	-	130	85	-	106
106AT20/60-0	A	60	381,97	379,12	-	-	130	85	-	106	

AT20 100 (rozteč 20 mm) pro šířku řemene 100 mm											
	Označení	Nákres	Zuby	Dp	De	Bočnice 0,5	Df	Dm	B1	B2	L
Hliník	123AT20/18-2	AF	18	114,59	111,73	Bm92	119	80	110	105	123
	123AT20/20-2	AF	20	127,32	124,47	Bm43	138	90	110	105	123
	123AT20/22-2	AF	22	140,06	137,20	Bm45	145	90	110	105	123
	123AT20/24-2	AF	24	152,79	149,93	Bm47	162	95	110	105	123
	123AT20/25-2	AF	25	159,15	156,30	Bm48	168	95	110	105	123
	123AT20/30-2	AF	30	190,99	188,13	Bm52	200	110	110	105	123
	123AT20/32-0	A	32	203,72	200,86	-	-	110	110	-	123
	123AT20/36-0	A	36	229,18	226,33	-	-	110	110	-	123
	123AT20/40-0	A	40	254,65	251,80	-	-	110	110	-	123
	123AT20/48-0	A	48	305,58	302,73	-	-	130	110	-	123
123AT20/60-0	A	60	381,97	379,12	-	-	130	110	-	123	

Hodnoty Df a Dm se mohou měnit bez předběžného upozornění



MXL 025 (rozteč 0,08" - 2,032mm) pro šířku řemene 0,25" - 6,35 mm											
	Označení	Nákres	Zuby	Dp	De	Bočnice 0,5	Df	Dm	B1	B2	L
Hliník	12 MXL 025 F	1F	12	7,76	7,25	Bm73	12,0	12	9	8	16
	13 MXL 025 F	1F	13	8,41	7,90	Bm73	12,0	12	9	8	16
	14 MXL 025 F	1F	14	9,06	8,55	Bm73	12,0	13	9	8	16
	15 MXL 025 F	1F	15	9,70	9,19	Bm73	12,0	14	9	8	16
	16 MXL 025 F	1F	16	10,35	9,84	Bm74	15,0	14	9	8	16
	17 MXL 025 F	1F	17	11,00	10,49	Bm74	15,0	15	9	8	16
	18 MXL 025 F	1F	18	11,64	11,13	Bm74	15,0	15	9	8	16
	19 MXL 025 F	1F	19	12,29	11,78	Bm75	16,0	16	9	8	16
	20 MXL 025 F	1F	20	12,94	12,43	Bm75	16,0	16	9	8	16
	21 MXL 025 F	AF	21	13,58	13,07	Bm75	16,0	10	11	9	16
	22 MXL 025 F	AF	22	14,23	13,72	Bm75	16,0	10	11	9	16
	24 MXL 025 F	AF	24	15,52	15,01	Bm0	19,5	11	11	9	16
	25 MXL 025 F	AF	25	16,17	15,66	Bm0	19,5	11	11	9	16
	28 MXL 025 F	AF	28	18,11	17,60	Bm1	23,0	11	11	9	16
	30 MXL 025 F	AF	30	19,40	18,89	Bm2	25,0	14	11	9	16
	32 MXL 025 F	AF	32	20,70	20,19	Bm2	25,0	14	11	9	16
	36 MXL 025 F	AF	36	23,29	22,78	Bm3	28,0	16	11	9	16
	40 MXL 025 F	AF	40	25,87	25,36	Bm4	32,0	18	11	9	16
	42 MXL 025 F	AF	42	27,17	26,66	Bm4	32,0	18	11	9	16
	44 MXL 025 F	AF	44	28,46	27,95	Bm4	32,0	18	11	9	16
	48 MXL 025	A	48	31,05	30,54	-	-	20	11	-	16
	60 MXL 025	A	60	38,81	38,3	-	-	24	11	-	16
65 MXL 025	A	65	42,04	41,53	-	-	25	11	-	16	
72 MXL 025	A	72	46,57	46,06	-	-	25	11	-	16	

XL 037 (rozteč 1/5" - 5,08 mm) pro šířku řemene 0,37" - 9,53 mm											
	Označení	Nákres	Zuby	Dp	De	Bočnice 1,0	Df	Dm	B1	B2	L
Hliník	10 XL 037 F	AF	10	16,17	15,66	Bm1	22	11,5	14,5	11,5	20
	11 XL 037 F	AF	11	17,79	17,28	Bm1	22	11,5	14,5	11,5	20
	12 XL 037 F	AF	12	19,40	18,89	Bm2	25	13,5	14,5	11,5	20
	13 XL 037 F	AF	13	21,02	20,51	Bm2	25	16	14,5	11,5	20
	14 XL 037 F	AF	14	22,64	22,13	Bm3	28	16	14,5	11,5	20
	15 XL 037 F	AF	15	24,26	23,75	Bm3	28	16	14,5	11,5	20
	16 XL 037 F	AF	16	25,87	25,36	Bm3	28	16	14,5	11,5	20
	17 XL 037 F	AF	17	27,49	26,98	Bm5	35	20	14,5	11,5	20
	18 XL 037 F	AF	18	29,11	28,60	Bm5	35	20	14,5	11,5	20
	19 XL 037 F	AF	19	30,72	30,21	Bm5	35	20	14,5	11,5	22
	20 XL 037 F	AF	20	32,34	31,83	Bm7	41	25	14,5	11,5	22
	21 XL 037 F	AF	21	33,96	33,45	Bm7	41	25	14,5	11,5	22
	22 XL 037 F	AF	22	35,57	35,07	Bm7	41	25	14,5	11,5	22
	24 XL 037 F	AF	24	38,81	38,30	Bm8	47	30	14,5	11,5	22
	26 XL 037 F	AF	26	42,04	41,53	Bm8	47	30	14,5	11,5	22
	27 XL 037 F	AF	27	43,67	43,16	Bm9	48	34	14,5	11,5	22
	28 XL 037 F	AF	28	45,28	44,77	Bm10	52	34	14,5	11,5	22
	29 XL 037 F	AF	29	46,89	46,38	Bm10	52	34	14,5	11,5	22
	30 XL 037 F	AF	30	48,51	48,00	Bm12	57	38	14,5	11,5	22
	32 XL 037 F	AF	32	51,74	51,23	Bm12	57	38	14,5	11,5	25
	34 XL 037	A	34	54,98	54,47	-	-	38	14,5	-	25
	35 XL 037	A	35	56,60	56,09	-	-	40	14,5	-	25
	36 XL 037	A	36	58,21	57,70	-	-	40	14,5	-	25
	38 XL 037	A	38	61,45	60,94	-	-	45	14,5	-	25
	39 XL 037	A	39	63,06	62,55	-	-	45	14,5	-	25
	40 XL 037	A	40	64,68	64,17	-	-	45	14,5	-	25
	41 XL 037	A	41	66,30	65,79	-	-	45	14,5	-	25
	42 XL 037	A	42	67,91	67,40	-	-	45	14,5	-	25
	43 XL 037	A	43	69,53	69,02	-	-	45	14,5	-	25
	44 XL 037	A	44	71,15	70,64	-	-	45	14,5	-	25
	45 XL 037	B	45	72,77	72,26	-	-	45	14,5	-	25
	46 XL 037	B	46	74,38	73,87	-	-	45	14,5	-	25
	47 XL 037	B	47	76,00	75,49	-	-	45	14,5	-	25
	48 XL 037	B	48	77,62	77,11	-	-	45	14,5	-	25
	49 XL 037	B	49	79,23	78,72	-	-	45	14,5	-	25
	50 XL 037	B	50	80,85	80,34	-	-	45	14,5	-	25
	52 XL 037	B	52	84,08	83,57	-	-	45	14,5	-	25
	56 XL 037	B	56	90,55	90,04	-	-	45	14,5	-	25
	60 XL 037	B	60	97,02	96,51	-	-	45	14,5	-	25
	68 XL 037	B	68	109,96	109,45	-	-	45	14,5	-	25
	70 XL 037	B	70	113,19	112,68	-	-	45	14,5	-	25
	72 XL 037	B	72	116,43	115,92	-	-	45	14,5	-	25
84 XL 037	B	84	135,83	135,32	-	-	50	14,5	-	25	
90 XL 037	B	90	145,53	145,02	-	-	70	14,5	-	25	

Hodnoty Df a Dm se mohou měnit bez předběžného upozornění

L 050 (rozeč 3/5" - 9,525 mm) pro šířku řemene 0,50" - 12,7 mm												
	Označení	Nákres	Zuby	Dp	De	Bočnice 0,5	Df	Dm	B1	B2	L	
Ocel	10 L 050 F	AF	10	30,32	29,56	Bm5	36	20	19	14	28	
	11 L 050 F	AF	11	33,35	32,59	Bm7	41	24	19	14	30	
	12 L 050 F	AF	12	36,38	35,62	Bm7	41	24	19	14	30	
	13 L 050 F	AF	13	39,41	38,65	Bm8	47	28	19	14	30	
	14 L 050 F	AF	14	42,45	41,69	Bm8	47	28	19	14	30	
	15 L 050 F	AF	15	45,48	44,72	Bm10	51	34	19	14	30	
	16 L 050 F	AF	16	48,51	47,75	Bm12	57	36	19	14	32	
	17 L 050 F	AF	17	51,54	50,78	Bm12	57	36	19	14	32	
	18 L 050 F	AF	18	54,57	53,81	Bm14	63	40	19	14	32	
	19 L 050 F	AF	19	57,61	56,85	Bm14	63	40	19	14	32	
	20 L 050 F	AF	20	60,64	59,88	Bm15	66	46	19	14	32	
	21 L 050 F	AF	21	63,67	62,91	Bm16	72	48	19	14	32	
	22 L 050 F	AF	22	66,70	65,94	Bm17	75	48	19	14	32	
	23 L 050 F	AF	23	69,73	68,97	Bm18	80	55	19	14	32	
	24 L 050 F	AF	24	72,77	72,01	Bm18	80	55	19	14	32	
	25 L 050 F	AF	25	75,80	75,04	Bm19	83	58	19	14	32	
	26 L 050 F	AF	26	78,83	78,07	Bm20	87	62	19	14	32	
	27 L 050 F	AF	27	81,86	81,10	Bm20	87	62	19	14	32	
	28 L 050 F	AF	28	84,89	84,13	Bm21	91	65	19	14	32	
	29 L 050 F	AF	29	87,93	87,17	Bm22	93	65	19	14	32	
	30 L 050 F	AF	30	90,96	90,20	Bm23	97	65	19	14	32	
	32 L 050 F	AF	32	97,02	96,26	Bm24	105	70	19	14	32	
	33 L 050 F	AF	33	100,05	99,29	Bm24	105	70	19	14	32	
	34 L 050 F	AF	34	103,08	102,32	Bm26	113	75	19	14	32	
	35 L 050 F	AF	35	106,12	105,36	Bm26	113	75	19	14	32	
	36 L 050 F	AF	36	109,15	108,39	Bm27	118	75	19	14	32	
	Litina	40 L 050 F	BF	40	121,28	120,52	Bm29	127	65	19	14	32
		41 L 050 F	BF	41	124,31	123,55	Bm31	131	65	19	14	32
		42 L 050 F	BF	42	127,34	126,58	Bm31	131	65	19	14	32
		44 L 050 F	BF	44	133,40	132,64	Bm32	135	65	19	14	32
		45 L 050 F	BF	45	136,44	135,68	Bm34	143	65	19	14	32
		47 L 050 F	BF	47	142,50	141,74	Bm36	152	65	19	14	32
		48 L 050 F	BF	48	145,53	144,76	Bm36	152	65	19	14	32
		50 L 050	B	50	151,60	150,84	-	-	65	19	-	32
		52 L 050	B	52	157,66	156,90	-	-	65	19	-	32
		56 L 050	B	56	169,79	169,03	-	-	65	19	-	32
57 L 050		B	57	172,82	172,06	-	-	65	19	-	32	
60 L 050		B	60	181,91	181,15	-	-	80	19	-	42	
72 L 050		B	72	218,30	217,54	-	-	75	19	-	42	
84 L 050		B	84	254,68	253,92	-	-	75	19	-	42	
90 L 050	B	90	272,87	272,11	-	-	100	19	-	45		

Hodnoty Df a Dm se mohou měnit bez předběžného upozornění

L 075 (rozeč 3/8" - 9,525 mm) pro šířku řemene 0/75" - 19,05 mm												
	Označení	Nákres	Zuby	Dp	De	Bočnice 0,5	Df	Dm	B1	B2	L	
<b>Ocel</b>	10 L 075 F	AF	10	30,32	29,56	Bm5	36	20	25,5	20,5	38	
	11 L 075 F	AF	11	33,35	32,59	Bm7	41	24	25,5	20,5	38	
	12 L 075 F	AF	12	36,38	35,62	Bm7	41	24	25,5	20,5	38	
	13 L 075 F	AF	13	39,41	38,65	Bm8	47	28	25,5	20,5	38	
	14 L 075 F	AF	14	42,45	41,69	Bm8	47	28	25,5	20,5	38	
	15 L 075 F	AF	15	45,48	44,72	Bm10	51	34	25,5	20,5	38	
	16 L 075 F	AF	16	48,51	47,75	Bm12	57	36	25,5	20,5	38	
	17 L 075 F	AF	17	51,54	50,78	Bm12	57	36	25,5	20,5	38	
	18 L 075 F	AF	18	54,57	53,81	Bm14	63	40	25,5	20,5	38	
	19 L 075 F	AF	19	57,61	56,85	Bm14	63	40	25,5	20,5	38	
	20 L 075 F	AF	20	60,64	59,88	Bm15	66	46	25,5	20,5	38	
	21 L 075 F	AF	21	63,67	62,91	Bm16	72	48	25,5	20,5	38	
	22 L 075 F	AF	22	66,70	65,94	Bm17	75	48	25,5	20,5	38	
	23 L 075 F	AF	23	69,73	68,97	Bm18	80	55	25,5	20,5	38	
	24 L 075 F	AF	24	72,77	72,01	Bm18	80	55	25,5	20,5	38	
	25 L 075 F	AF	25	75,80	75,04	Bm19	83	58	25,5	20,5	38	
	26 L 075 F	AF	26	78,83	78,07	Bm20	87	62	25,5	20,5	38	
	27 L 075 F	AF	27	81,86	81,10	Bm20	87	62	25,5	20,5	38	
	28 L 075 F	AF	28	84,89	84,13	Bm21	91	65	25,5	20,5	38	
	29 L 075 F	AF	29	87,93	87,17	Bm22	93	65	25,5	20,5	38	
	30 L 075 F	AF	30	90,96	90,20	Bm23	97	65	25,5	20,5	38	
	32 L 075 F	AF	32	97,02	96,26	Bm24	105	70	25,5	20,5	38	
	33 L 075 F	AF	33	100,05	99,29	Bm24	105	70	25,5	20,5	38	
	34 L 075 F	AF	34	103,08	102,32	Bm26	113	75	25,5	20,5	38	
	35 L 075 F	AF	35	106,12	105,36	Bm26	113	75	25,5	20,5	38	
	36 L 075 F	AF	36	109,15	108,39	Bm27	118	75	25,5	20,5	38	
	<b>Litina</b>	40 L 075 F	BF	40	121,28	120,52	Bm29	127	65	25,5	20,5	38
		41 L 075 F	BF	41	124,31	123,55	Bm31	131	65	25,5	20,5	38
		42 L 075 F	BF	42	127,34	126,58	Bm31	131	65	25,5	20,5	38
		44 L 075 F	BF	44	133,40	132,64	Bm32	135	65	25,5	20,5	38
		45 L 075 F	BF	45	136,44	135,68	Bm34	143	65	25,5	20,5	38
		47 L 075 F	BF	47	142,50	141,74	Bm36	152	65	25,5	20,5	38
		48 L 075 F	BF	48	145,53	144,76	Bm36	152	65	25,5	20,5	38
		50 L 075	B	50	151,60	150,84	-	-	65	25,5	-	38
		52 L 075	B	52	157,66	156,90	-	-	65	25,5	-	38
		56 L 075	B	56	169,79	169,03	-	-	65	25,5	-	38
57 L 075		B	57	172,82	172,06	-	-	65	25,5	-	38	
60 L 075		B	60	181,91	181,15	-	-	80	25,5	-	45	
72 L 075		B	72	218,30	217,54	-	-	75	25,5	-	45	
84 L 075		B	84	254,68	253,92	-	-	75	25,5	-	45	

Hodnoty Df a Dm se mohou měnit bez předběžného upozornění

L 100 (rozetč 3/8" - 9,525 mm) pro šířku řemene 1,00" - 25,4 mm												
	Označení	Nákres	Zuby	Dp	De	Bočnice 0,5	Df	Dm	B1	B2	L	
Ocel	10 L 100 F	AF	10	30,32	29,56	Bm5	36	20	32	27	45	
	11 L 100 F	AF	11	33,35	32,59	Bm7	41	24	32	27	45	
	12 L 100 F	AF	12	36,38	35,62	Bm7	41	24	32	27	45	
	13 L 100 F	AF	13	39,41	38,65	Bm8	47	28	32	27	45	
	14 L 100 F	AF	14	42,45	41,69	Bm8	47	28	32	27	45	
	15 L 100 F	AF	15	45,48	44,72	Bm10	51	34	32	27	45	
	16 L 100 F	AF	16	48,51	47,75	Bm12	57	36	32	27	45	
	17 L 100 F	AF	17	51,54	50,78	Bm12	57	36	32	27	45	
	18 L 100 F	AF	18	54,57	53,81	Bm14	63	40	32	27	45	
	19 L 100 F	AF	19	57,61	56,85	Bm14	63	40	32	27	45	
	20 L 100 F	AF	20	60,64	59,88	Bm15	66	46	32	27	45	
	21 L 100 F	AF	21	63,67	62,91	Bm16	72	48	32	27	45	
	22 L 100 F	AF	22	66,70	65,94	Bm17	75	48	32	27	45	
	23 L 100 F	AF	23	69,73	68,97	Bm18	80	55	32	27	45	
	24 L 100 F	AF	24	72,77	72,01	Bm18	80	55	32	27	45	
	25 L 100 F	AF	25	75,80	75,04	Bm19	83	58	32	27	45	
	26 L 100 F	AF	26	78,83	78,07	Bm20	87	62	32	27	45	
	27 L 100 F	AF	27	81,86	81,10	Bm20	87	62	32	27	45	
	28 L 100 F	AF	28	84,89	84,13	Bm21	91	65	32	27	45	
	29 L 100 F	AF	29	87,93	87,17	Bm22	93	65	32	27	45	
	30 L 100 F	AF	30	90,96	90,20	Bm23	97	65	32	27	45	
	32 L 100 F	AF	32	97,02	96,26	Bm24	105	70	32	27	45	
	33 L 100 F	AF	33	100,05	99,29	Bm24	105	70	32	27	45	
	34 L 100 F	AF	34	103,08	102,32	Bm26	113	75	32	27	45	
	35 L 100 F	AF	35	106,12	105,36	Bm26	113	75	32	27	45	
	36 L 100 F	AF	36	109,15	108,39	Bm27	118	75	32	27	45	
	Litina	40 L 100 F	BF	40	121,28	120,52	Bm29	127	65	32	27	45
		41 L 100 F	BF	41	124,31	123,55	Bm31	131	65	32	27	45
		42 L 100 F	BF	42	127,34	126,58	Bm31	131	65	32	27	45
		44 L 100 F	BF	44	133,40	132,64	Bm32	135	65	32	27	45
		45 L 100 F	BF	45	136,44	135,68	Bm34	143	65	32	27	45
		47 L 100 F	BF	47	142,50	141,74	Bm36	152	65	32	27	45
		48 L 100 F	BF	48	145,53	144,76	Bm36	152	65	32	27	45
		50 L 100	B	50	151,60	150,84	-	-	65	32	-	45
		52 L 100	B	52	157,66	156,90	-	-	65	32	-	45
		56 L 100	B	56	169,79	169,03	-	-	65	32	-	45
57 L 100		B	57	172,82	172,06	-	-	65	32	-	45	
60 L 100		B	60	181,91	181,15	-	-	70	32	-	50	
72 L 100		B	72	218,30	217,54	-	-	75	32	-	50	
84 L 100		B	84	254,68	253,92	-	-	75	32	-	50	

Hodnoty Df a Dm se mohou měnit bez předběžného upozornění

H 075 (rozteč 1/2" - 12,7 mm) pro šířku řemene 0,75" - 19,05 mm											
	Označení	Nákres	Zuby	Dp	De	Bočnice 0,5	Df	Dm	B1	B2	L
Ocel	14 H 075 F	AF	14	56,60	55,23	Bm14	63	41	25,5	20,5	40
	15 H 075 F	AF	15	60,64	59,27	Bm15	66	45	25,5	20,5	40
	16 H 075 F	AF	16	64,68	63,31	Bm16	72	49	25,5	20,5	40
	17 H 075 F	AF	17	68,72	67,35	Bm17	75	52	25,5	20,5	40
	18 H 075 F	AF	18	72,77	71,40	Bm18	80	57	25,5	20,5	40
	19 H 075 F	AF	19	76,81	75,44	Bm19	83	61	25,5	20,5	40
	20 H 075 F	AF	20	80,85	79,48	Bm20	87	62	25,5	20,5	40
	21 H 075 F	AF	21	84,89	83,52	Bm21	91	67	25,5	20,5	40
	22 H 075 F	AF	22	88,94	87,57	Bm23	97	70	25,5	20,5	40
	23 H 075 F	AF	23	92,98	91,61	Bm23	97	75	25,5	20,5	40
Litina	24 H 075 F	AF	24	97,02	95,65	Bm24	105	75	25,5	20,5	40
	25 H 075 F	AF	25	101,06	99,69	Bm24	105	80	25,5	20,5	40
	26 H 075 F	AF	26	105,11	103,74	Bm26	113	80	25,5	20,5	40
	27 H 075 F	AF	27	109,15	107,78	Bm27	118	80	25,5	20,5	40
	28 H 075 F	AF	28	113,19	111,82	Bm28	119	80	25,5	20,5	40
	29 H 075 F	AF	29	117,23	115,86	Bm28	119	80	25,5	20,5	40
	30 H 075 F	AF	30	121,28	119,91	Bm29	127	80	25,5	20,5	40
	32 H 075 F	AF	32	129,36	127,99	Bm32	135	80	25,5	20,5	40
	33 H 075 F	BF	33	133,40	132,03	Bm32	135	80	25,5	20,5	40
	34 H 075 F	BF	34	137,45	136,08	Bm34	143	80	25,5	20,5	40
	35 H 075 F	BF	35	141,49	140,12	Bm36	152	80	25,5	20,5	40
	36 H 075 F	BF	36	145,53	144,16	Bm36	152	80	25,5	20,5	40
	38 H 075 F	BF	38	153,62	152,25	Bm37	160	80	25,5	20,5	40
	40 H 075 F	BF	40	161,70	160,33	Bm38	168	80	25,5	20,5	40
	44 H 075 F	BF	44	177,87	176,50	Bm40	182	80	25,5	20,5	40
	45 H 075 F	BF	45	181,91	180,54	Bm41	194	90	25,5	20,5	45
	48 H 075 F	BF	48	194,04	192,67	Bm42	200	90	25,5	20,5	45
50 H 075	B	50	202,13	200,76	-	-	90	25,5	-	45	

Hodnoty Df a Dm se mohou měnit bez předběžného upozornění



H 100 (rozteč 1/2" - 12,7 mm) pro šířku řemene 1,00" - 25,4 mm											
	Označení	Nákres	Zuby	Dp	De	Bočnice 0,5	Df	Dm	B1	B2	L
Ocel	14 H 100 F	AF	14	56,60	55,23	Bm14	63	41	32	27	45
	15 H 100 F	AF	15	60,64	59,27	Bm15	66	45	32	27	45
	16 H 100 F	AF	16	64,68	63,31	Bm16	72	49	32	27	45
	17 H 100 F	AF	17	68,72	67,35	Bm17	75	52	32	27	45
	18 H 100 F	AF	18	72,77	71,40	Bm18	80	57	32	27	45
	19 H 100 F	AF	19	76,81	75,44	Bm19	83	61	32	27	45
	20 H 100 F	AF	20	80,85	79,48	Bm20	87	62	32	27	45
	21 H 100 F	AF	21	84,89	83,52	Bm21	91	67	32	27	45
	22 H 100 F	AF	22	88,94	87,57	Bm23	97	70	32	27	45
	23 H 100 F	AF	23	92,98	91,61	Bm23	97	75	32	27	45
	24 H 100 F	AF	24	97,02	95,65	Bm24	105	75	32	27	45
	25 H 100 F	AF	25	101,06	99,69	Bm24	105	80	32	27	45
	26 H 100 F	AF	26	105,11	103,74	Bm26	113	80	32	27	45
	27 H 100 F	AF	27	109,15	107,78	Bm27	118	80	32	27	45
	28 H 100 F	AF	28	113,19	111,82	Bm28	119	80	32	27	45
	29 H 100 F	AF	29	117,23	115,86	Bm28	119	80	32	27	45
	30 H 100 F	AF	30	121,28	119,91	Bm29	127	80	32	27	45
	32 H 100 F	AF	32	129,36	127,99	Bm32	135	80	32	27	45
	33 H 100 F	BF	33	133,40	132,03	Bm32	135	80	32	27	45
	34 H 100 F	BF	34	137,45	136,08	Bm34	143	80	32	27	45
	35 H 100 F	BF	35	141,49	140,12	Bm36	152	80	32	27	45
	Litina	36 H 100 F	BF	36	145,53	144,16	Bm36	152	80	32	27
38 H 100 F		BF	38	153,62	152,25	Bm37	160	80	32	27	45
40 H 100 F		BF	40	161,70	160,33	Bm38	168	80	32	27	45
44 H 100 F		BF	44	177,87	176,50	Bm40	182	80	32	27	50
45 H 100 F		BF	45	181,91	180,54	Bm41	194	90	32	27	50
48 H 100 F		BF	48	194,04	192,67	Bm42	200	90	32	27	50
50 H 100		B	50	202,13	200,76	-	-	90	32	-	50
52 H 100		B	52	210,21	208,84	-	-	90	32	-	50
58 H 100		B	58	234,47	233,10	-	-	90	32	-	50
60 H 100		C	60	242,55	241,18	-	-	90	32	-	55
70 H 100		C	70	282,98	281,61	-	-	90	32	-	55
72 H 100		C	72	291,06	289,69	-	-	100	32	-	55
84 H 100		C	84	339,57	338,20	-	-	100	32	-	55
96 H 100		C	96	388,08	386,71	-	-	120	32	-	60

Hodnoty Df a Dm se mohou měnit bez předběžného upozornění

H 150 (rozteč 1/2" - 12,7 mm) pro šířku řemene 1,50" - 38,1 mm											
	Označení	Nákres	Zuby	Dp	De	Bočnice 1,5	Df	Dm	B1	B2	L
Ocel	14 H 150 F	AF	14	56,60	55,23	Bm14	63	41	46	41	58
	15 H 150 F	AF	15	60,64	59,27	Bm15	66	45	46	41	58
	16 H 150 F	AF	16	64,68	63,31	Bm16	72	49	46	41	58
	17 H 150 F	AF	17	68,72	67,35	Bm17	75	52	46	41	58
	18 H 150 F	AF	18	72,77	71,40	Bm18	80	57	46	41	58
	19 H 150 F	AF	19	76,81	75,44	Bm19	83	61	46	41	58
	20 H 150 F	AF	20	80,85	79,48	Bm20	87	62	46	41	58
	21 H 150 F	AF	21	84,89	83,52	Bm21	91	67	46	41	58
	22 H 150 F	AF	22	88,94	87,57	Bm23	97	70	46	41	58
	23 H 150 F	AF	23	92,98	91,61	Bm23	97	75	46	41	58
	24 H 150 F	AF	24	97,02	95,65	Bm24	105	75	46	41	58
	25 H 150 F	AF	25	101,06	99,69	Bm24	105	80	46	41	58
	26 H 150 F	AF	26	105,11	103,74	Bm26	113	80	46	41	58
	27 H 150 F	AF	27	109,15	107,78	Bm27	118	80	46	41	58
	28 H 150 F	AF	28	113,19	111,82	Bm28	119	80	46	41	58
	29 H 150 F	AF	29	117,23	115,86	Bm28	119	80	46	41	58
	30 H 150 F	AF	30	121,28	119,91	Bm29	127	80	46	41	58
	32 H 150 F	AF	32	129,36	127,99	Bm32	135	80	46	41	58
	33 H 150 F	BF	33	133,40	132,03	Bm32	135	75	46	41	58
	34 H 150 F	BF	34	137,45	136,08	Bm34	143	80	46	41	58
	35 H 150 F	BF	35	141,49	140,12	Bm36	152	80	46	41	58
	36 H 150 F	BF	36	145,53	144,16	Bm36	152	80	46	41	58
	38 H 150 F	BF	38	153,62	152,25	Bm37	160	80	46	41	58
40 H 150 F	BF	40	161,70	160,33	Bm38	168	79	46	41	58	
44 H 150 F	BF	44	177,87	176,50	Bm40	182	80	46	41	58	
45 H 150 F	BF	45	181,91	180,54	Bm41	194	90	46	41	65	
48 H 150 F	BF	48	194,04	192,67	Bm42	200	90	46	41	65	
50 H 150	B	50	202,13	200,76	-	-	90	46	-	65	
52 H 150	B	52	210,21	208,84	-	-	90	46	-	65	
58 H 150	B	58	234,47	233,10	-	-	90	46	-	65	
60 H 150	C	60	242,55	241,18	-	-	85	46	-	65	
70 H 150	C	70	282,98	281,61	-	-	90	46	-	65	
72 H 150	C	72	291,06	289,69	-	-	100	46	-	65	
84 H 150	C	84	339,57	338,20	-	-	100	46	-	65	
96 H 150	C	96	388,08	386,71	-	-	120	46	-	65	

Hodnoty Df a Dm se mohou měnit bez předběžného upozornění

H 200 (rozteč 1/2" - 12,7 mm) pro šířku řemene 2,00" - 50,8 mm											
	Označení	Nákres	Zuby	Dp	De	Bočnice 1,5	Df	Dm	B1	B2	L
Ocel	14 H 200 F	AF	14	56,60	55,23	Bm14	63	41	59	54	70
	15 H 200 F	AF	15	60,64	59,27	Bm15	66	45	59	54	70
	16 H 200 F	AF	16	64,68	63,31	Bm16	72	49	59	54	70
	17 H 200 F	AF	17	68,72	67,35	Bm17	75	52	59	54	70
	18 H 200 F	AF	18	72,77	71,40	Bm18	80	57	59	54	70
	19 H 200 F	AF	19	76,81	75,44	Bm19	83	61	59	54	70
	20 H 200 F	AF	20	80,85	79,48	Bm20	87	62	59	54	70
	21 H 200 F	AF	21	84,89	83,52	Bm21	91	67	59	54	70
	22 H 200 F	AF	22	88,94	87,57	Bm23	97	70	59	54	70
	23 H 200 F	AF	23	92,98	91,61	Bm23	97	75	59	54	70
Litina	24 H 200 F	AF	24	97,02	95,65	Bm24	105	75	59	54	70
	25 H 200 F	AF	25	101,06	99,69	Bm24	105	80	59	54	70
	26 H 200 F	AF	26	105,11	103,74	Bm26	113	80	59	54	70
	27 H 200 F	AF	27	109,15	107,78	Bm27	118	80	59	54	70
	28 H 200 F	AF	28	113,19	111,82	Bm28	119	80	59	54	70
	29 H 200 F	AF	29	117,23	115,86	Bm28	119	80	59	54	70
	30 H 200 F	AF	30	121,28	119,91	Bm29	127	80	59	54	70
	32 H 200 F	AF	32	129,36	127,99	Bm32	135	80	59	54	70
	33 H 200 F	BF	33	133,40	132,03	Bm32	135	80	59	54	70
	34 H 200 F	BF	34	137,45	136,08	Bm34	143	80	59	54	70
	35 H 200 F	BF	35	141,49	140,12	Bm36	152	80	59	54	70
	36 H 200 F	BF	36	145,53	144,16	Bm36	152	80	59	54	70
	38 H 200 F	BF	38	153,62	152,25	Bm37	160	80	59	54	70
	40 H 200 F	BF	40	161,70	160,33	Bm38	168	80	59	54	70
	44 H 200 F	BF	44	177,87	176,50	Bm40	182	80	59	54	75
	45 H 200 F	BF	45	181,91	180,54	Bm41	194	90	59	54	75
	48 H 200 F	BF	48	194,04	192,67	Bm42	200	90	59	54	75
	50 H 200	B	50	202,13	200,76	-	-	90	59	-	75
	52 H 200	B	52	210,21	208,84	-	-	90	59	-	75
	58 H 200	B	58	234,47	233,10	-	-	90	59	-	75
60 H 200	C	60	242,55	241,18	-	-	90	59	-	75	
70 H 200	C	70	282,98	281,61	-	-	90	59	-	75	
72 H 200	C	72	291,06	289,69	-	-	100	59	-	75	
84 H 200	C	84	339,57	338,20	-	-	100	59	-	75	
96 H 200	C	96	388,08	386,71	-	-	120	59	-	75	

Hodnoty Df a Dm se mohou měnit bez předběžného upozornění

H 300 (rozteč 1/2" - 1 2,7 mm) pro šířku řemene 3,00" - 76,2 mm											
	Označení	Nákres	Zuby	Dp	De	Bočnice 1,5	Df	Dm	B1	B2	L
Ocel	14 H 300 F	AF	14	56,60	55,23	Bm14	63	41	85	80	100
	15 H 300 F	AF	15	60,64	59,27	Bm15	66	45	85	80	100
	16 H 300 F	AF	16	64,68	63,31	Bm16	72	49	85	80	100
	17 H 300 F	AF	17	68,72	67,35	Bm17	75	52	85	80	100
	18 H 300 F	AF	18	72,77	71,40	Bm18	80	57	85	80	100
	19 H 300 F	AF	19	76,81	75,44	Bm19	83	61	85	80	100
	20 H 300 F	AF	20	80,85	79,48	Bm20	87	62	85	80	100
	21 H 300 F	AF	21	84,89	83,52	Bm21	91	67	85	80	100
	22 H 300 F	AF	22	88,94	87,57	Bm23	97	70	85	80	100
	23 H 300 F	AF	23	92,98	91,61	Bm23	97	75	85	80	100
Litina	24 H 300 F	AF	24	97,02	95,65	Bm24	105	75	85	80	100
	25 H 300 F	AF	25	101,06	99,69	Bm24	105	80	85	80	100
	26 H 300 F	AF	26	105,11	103,74	Bm26	113	80	85	80	100
	27 H 300 F	AF	27	109,15	107,78	Bm27	118	80	85	80	100
	28 H 300 F	AF	28	113,19	111,82	Bm28	119	80	85	80	100
	29 H 300 F	AF	29	117,23	115,86	Bm28	119	80	85	80	100
	30 H 300 F	AF	30	121,28	119,91	Bm29	127	80	85	80	100
	32 H 300 F	AF	32	129,36	127,99	Bm32	135	80	85	80	100
	33 H 300 F	BF	33	133,40	132,03	Bm32	135	80	85	80	100
	34 H 300 F	BF	34	137,45	136,08	Bm34	143	80	85	80	100
	35 H 300 F	BF	35	141,49	140,12	Bm36	152	80	85	80	100
	36 H 300 F	BF	36	145,53	144,16	Bm36	152	80	85	80	100
	38 H 300 F	BF	38	153,62	152,25	Bm37	160	80	85	80	100
	40 H 300 F	BF	40	161,70	160,33	Bm38	168	80	85	80	100
	44 H 300 F	BF	44	177,87	176,50	Bm40	182	80	85	80	100
	45 H 300 F	BF	45	181,91	180,54	Bm41	194	90	85	80	100
	48 H 300 F	BF	48	194,04	192,67	Bm42	200	90	85	80	100
	50 H 300	B	50	202,13	200,76	-	-	90	85	-	100
	52 H 300	B	52	210,21	208,84	-	-	90	85	-	100
	58 H 300	C	58	234,47	233,10	-	-	90	85	-	100
60 H 300	C	60	242,55	241,18	-	-	90	85	-	100	
70 H 300	C	70	282,98	281,61	-	-	90	85	-	100	
72 H 300	C	72	291,06	289,69	-	-	100	85	-	100	
84 H 300	C	84	339,57	338,20	-	-	100	85	-	100	
96 H 300	C	96	388,08	386,71	-	-	120	85	-	100	

Hodnoty Df a Dm se mohou měnit bez předběžného upozornění

XH 200 (rozteč 7/8" - 22,225 mm) pro šířku řemene 2,00" - 50,8 mm											
	Označení	Nákres	Zuby	Dp	De	Bočnice 1,5	Df	Dm	B1	B2	L
Litina	18 XH 200 F	AF	18	127,34	124,55	Bm43	136	100	65	57	80
	20 XH 200 F	AF	20	141,49	138,70	Bm45	155	100	65	57	80
	22 XH 200 F	AF	22	155,64	152,83	Bm46	162	110	65	57	80
	24 XH 200 F	AF	24	169,79	167,00	Bm48	176	120	65	57	80
	26 XH 200 F	AF	26	183,92	181,13	Bm50	191	150	65	57	80
	28 XH 200 F	AF	28	198,08	195,29	Bm56	213	150	65	57	80
	30 XH 200 F	AF	30	212,23	209,44	Bm57	225	150	65	57	80
	32 XH 200 F	AF	32	226,38	223,59	Bm60	240	150	65	57	80
	40 XH 200 F	BF	40	282,98	280,19	Bm63	290	150	65	57	100
	44 XH 200	B	44	311,28	308,48	-	-	150	65	-	100
48 XH 200	B	48	339,57	336,78	-	-	150	65	-	100	

XH 300 (rozteč 7/8" - 22,225 mm) pro šířku řemene 3,00" - 76,2 mm											
	Označení	Nákres	Zuby	Dp	De	Bočnice 1,5	Df	Dm	B1	B2	L
Litina	18 XH 300 F	AF	18	127,34	124,55	Bm43	136	100	92	84	110
	20 XH 300 F	AF	20	141,49	138,70	Bm45	155	100	92	84	110
	22 XH 300 F	AF	22	155,64	152,83	Bm46	162	110	92	84	110
	24 XH 300 F	AF	24	169,79	167,00	Bm48	176	120	92	84	110
	26 XH 300 F	AF	26	183,92	181,13	Bm50	191	150	92	84	110
	28 XH 300 F	AF	28	198,08	195,29	Bm56	210	150	92	84	110
	30 XH 300 F	AF	30	212,23	209,44	Bm57	225	150	92	84	110
	32 XH 300 F	AF	32	226,38	223,59	Bm60	240	150	92	84	110
	40 XH 300 F	BF	40	282,98	280,19	Bm63	290	150	92	84	120
	44 XH 300	B	44	311,28	308,48	-	-	150	92	-	120
48 XH 300	B	48	339,57	336,78	-	-	150	92	-	120	

XH 400 (rozteč 7/8" - 22,225 mm) pro šířku řemene 4,00" - 101,6 mm											
	Označení	Nákres	Zuby	Dp	De	Bočnice 1,5	Df	Dm	B1	B2	L
Litina	18 XH 400 F	AF	18	127,34	124,55	Bm43	136	100	119	111	132
	20 XH 400 F	AF	20	141,49	138,70	Bm45	155	100	119	111	132
	22 XH 400 F	AF	22	155,64	152,83	Bm46	162	110	119	111	132
	24 XH 400 F	AF	24	169,79	167,00	Bm48	176	120	119	111	132
	26 XH 400 F	AF	26	183,92	181,13	Bm50	191	150	119	111	132
	28 XH 400 F	AF	28	198,08	195,29	Bm56	210	150	119	111	132
	30 XH 400 F	AF	30	212,23	209,44	Bm57	225	150	119	111	132
	32 XH 400 F	AF	32	226,38	223,59	Bm60	240	150	119	111	132
	40 XH 400 F	BF	40	282,98	280,19	Bm63	290	150	119	111	132
	44 XH 400	B	44	311,28	308,48	-	-	150	119	-	132
48 XH 400	B	48	339,57	336,78	-	-	150	119	-	132	

Hodnoty Df a Dm se mohou měnit bez předběžného upozornění



HTD 3M 06 (rozteč 3 mm) pro šířku řemene 6 mm											
	Označení	Nákres	Zuby	Dp	De	Bočnice 1,5	Df	Dm	B1	B2	L
Hliník	10 3M 06 F	1F	10	9,55	8,79	Bm73	12	12	-	7,3	14,5
	12 3M 06 F	1F	12	11,46	10,70	Bm74	15	13	-	7,3	14,5
	14 3M 06 F	1F	14	13,37	12,61	Bm75	16	17	-	7,3	14,5
	15 3M 06 F	1F	15	14,32	13,56	Bm75	16	17	-	7,3	14,5
	16 3M 06 F	AF	16	15,28	14,52	Bm0	19,5	10	10,3	7,3	17,5
	18 3M 06 F	AF	18	17,19	16,43	Bm1	22	11	10,3	7,3	17,5
	20 3M 06 F	AF	20	19,10	18,34	Bm2	25	11	10,3	7,3	17,5
	21 3M 06 F	AF	21	20,05	19,29	Bm2	25	14	10,3	7,3	17,5
	22 3M 06 F	AF	22	21,01	20,25	Bm2	25	14	10,3	7,3	17,5
	24 3M 06 F	AF	24	22,92	22,16	Bm3	28	14	10,3	7,3	17,5
	26 3M 06 F	AF	26	24,83	24,07	Bm3	28	16	10,3	7,3	17,5
	28 3M 06 F	AF	28	26,74	25,98	Bm4	32	16	10,3	7,3	17,5
	30 3M 06 F	AF	30	28,65	27,89	Bm4	32	16	10,3	7,3	17,5
	32 3M 06 F	AF	32	30,56	29,80	Bm5	36	20	10,3	7,3	17,5
	36 3M 06 F	AF	36	34,38	33,62	Bm6	38	24	10,3	7,3	18
	40 3M 06 F	AF	40	38,20	37,44	Bm7	41	26	10,3	7,3	18
	44 3M 06 F	AF	44	42,02	41,25	Bm8	47	30	10,3	7,3	18
48 3M 06	A	48	45,84	45,07	-	-	35	10,3	-	18,6	
60 3M 06	A	60	57,30	56,53	-	-	40	10,3	-	18,6	
72 3M 06	A	72	68,75	67,99	-	-	40	10,3	-	18,6	

HTD 3M 09 (rozteč 3 mm) pro šířku řemene 9 mm											
	Označení	Nákres	Zuby	Dp	De	Bočnice 1,5	Df	Dm	B1	B2	L
Hliník	10 3M 09 F	1F	10	9,55	8,79	Bm73	12	12	-	11	18
	12 3M 09 F	1F	12	11,46	10,70	Bm74	15	13	-	11	18
	14 3M 09 F	1F	14	13,37	12,61	Bm75	16	17	-	11	18
	15 3M 09 F	1F	15	14,32	13,56	Bm75	16	17	-	11	18
	16 3M 09 F	AF	16	15,28	14,52	Bm0	19,5	10	14	11	21
	18 3M 09 F	AF	18	17,19	16,43	Bm1	22	11	14	11	21
	20 3M 09 F	AF	20	19,10	18,34	Bm2	25	11	14	11	21
	21 3M 09 F	AF	21	20,05	19,29	Bm2	25	14	14	11	21
	22 3M 09 F	AF	22	21,01	20,25	Bm2	25	14	14	11	21
	24 3M 09 F	AF	24	22,92	22,16	Bm3	28	14	14	11	21
	26 3M 09 F	AF	26	24,83	24,07	Bm3	28	16	14	11	21
	28 3M 09 F	AF	28	26,74	25,98	Bm4	32	16	14	11	21
	30 3M 09 F	AF	30	28,65	27,89	Bm4	32	16	14	11	21
	32 3M 09 F	AF	32	30,56	29,80	Bm5	36	20	14	11	21
	36 3M 09 F	AF	36	34,38	33,62	Bm6	38	24	14	11	22,5
	40 3M 09 F	AF	40	38,20	37,44	Bm7	41	26	14	11	22,5
	44 3M 09 F	AF	44	42,02	41,25	Bm8	47	30	14	11	22,5
48 3M 09	A	48	45,84	45,07	-	-	35	14	-	22,5	
60 3M 09	A	60	57,30	56,53	-	-	40	14	-	22,5	
72 3M 09	A	72	68,75	67,99	-	-	40	14	-	22,5	

HTD 3M 15 (rozteč 3 mm) pro šířku řemene 15 mm											
	Označení	Nákres	Zuby	Dp	De	Bočnice 1,5	Df	Dm	B1	B2	L
Hliník	10 3M 15 F	1F	10	9,55	8,79	Bm73	12	12	-	17	26
	12 3M 15 F	1F	12	11,46	10,70	Bm74	15	13	-	17	26
	14 3M 15 F	1F	14	13,37	12,61	Bm75	16	17	-	17	26
	15 3M 15 F	1F	15	14,32	13,56	Bm75	16	17	-	17	26
	16 3M 15 F	AF	16	15,28	14,52	Bm0	19,5	10	20	17	26
	18 3M 15 F	AF	18	17,19	16,43	Bm1	22	11	20	17	26
	20 3M 15 F	AF	20	19,10	18,34	Bm2	25	11	20	17	26
	21 3M 15 F	AF	21	20,05	19,29	Bm2	25	14	20	17	26
	22 3M 15 F	AF	22	21,01	20,25	Bm2	25	14	20	17	26
	24 3M 15 F	AF	24	22,92	22,16	Bm3	28	14	20	17	26
	26 3M 15 F	AF	26	24,83	24,07	Bm3	28	16	20	17	26
	28 3M 15 F	AF	28	26,74	25,98	Bm4	32	16	20	17	26
	30 3M 15 F	AF	30	28,65	27,89	Bm4	32	16	20	17	26
	32 3M 15 F	AF	32	30,56	29,80	Bm5	36	20	20	17	26
	36 3M 15 F	AF	36	34,38	33,62	Bm6	38	24	20	17	26
	40 3M 15 F	AF	40	38,20	37,44	Bm7	41	26	20	17	26
	44 3M 15 F	AF	44	42,02	41,25	Bm8	47	30	20	17	26
48 3M 15	A	48	45,84	45,07	-	-	35	20	-	26	
60 3M 15	A	60	57,30	56,53	-	-	40	20	-	26	
72 3M 15	A	72	68,75	67,99	-	-	40	20	-	26	

Hodnoty Df a Dm se mohou měnit bez předběžného upozornění\* Nelle forme costruttive gli scarichi di alleggerimento possono leggermente variare

HTD 5M 09 (rozeč 5 mm) pro šířku řemene 9 mm											
	Označení	Nákres	Zuby	Dp	De	Bočnice 1,5	Df	Dm	B1	B2	L
Ocel	12 5M 09 F	AF	12	19,09	17,95	Bm1	22	12	14,5	11	20
	14 5M 09 F	AF	14	22,28	21,14	Bm2	25	14	14,5	11	20
	15 5M 09 F	AF	15	23,87	22,73	Bm3	28	16	14,5	11	20
	16 5M 09 F	AF	16	25,46	24,32	Bm3	28	16	14,5	11	20
	18 5M 09 F	AF	18	28,65	27,50	Bm4	32	20	14,5	11	20
	20 5M 09 F	AF	20	31,83	30,69	Bm5	36	23	14,5	11	23
	21 5M 09 F	AF	21	33,42	32,28	Bm6	38	24	14,5	11	23
	22 5M 09 F	AF	22	35,01	33,87	Bm6	38	24	14,5	11	23
	24 5M 09 F	AF	24	38,20	37,05	Bm7	41	27	14,5	11	23
	26 5M 09 F	AF	26	41,38	40,24	Bm8	47	30	14,5	11	23
	28 5M 09 F	AF	28	44,56	43,42	Bm8	47	30	14,5	11	23
	30 5M 09 F	AF	30	47,75	46,60	Bm10	51	35	14,5	11	23
	32 5M 09 F	AF	32	50,93	49,79	Bm12	57	38	14,5	11	23
	36 5M 09 F	AF	36	57,30	56,15	Bm14	63	38	14,5	11	23
	40 5M 09 F	AF	40	63,66	62,52	Bm15	66	45	14,5	11	23
Alum	44 5M 09	A	44	70,03	68,89	-	-	45	14,5	-	26
	48 5M 09	A	48	76,39	75,25	-	-	45	14,5	-	26
	60 5M 09	B	60	95,49	94,35	-	-	45	14,5	-	26
	72 5M 09	B	72	114,59	113,45	-	-	47	14,5	-	26

HTD 5M 15 (rozeč 5 mm) pro šířku řemene 15 mm											
	Označení	Nákres	Zuby	Dp	De	Bočnice 1,5	Df	Dm	B1	B2	L
Ocel	12 5M 15 F	AF	12	19,09	17,95	Bm1	22	12	20,5	17	26
	14 5M 15 F	AF	14	22,28	21,14	Bm2	25	14	20,5	17	26
	15 5M 15 F	AF	15	23,87	22,73	Bm3	28	16	20,5	17	26
	16 5M 15 F	AF	16	25,46	24,32	Bm3	28	16	20,5	17	26
	18 5M 15 F	AF	18	28,65	27,50	Bm4	32	20	20,5	17	26
	20 5M 15 F	AF	20	31,83	30,69	Bm5	36	23	20,5	17	26
	21 5M 15 F	AF	21	33,42	32,28	Bm6	38	24	20,5	17	26
	22 5M 15 F	AF	22	35,01	33,87	Bm6	38	25	20,5	17	26
	24 5M 15 F	AF	24	38,20	37,05	Bm7	41	27	20,5	17	28
	26 5M 15 F	AF	26	41,38	40,24	Bm8	47	30	20,5	17	28
	28 5M 15 F	AF	28	44,56	43,42	Bm8	47	30	20,5	17	28
	30 5M 15 F	AF	30	47,75	46,60	Bm10	51	35	20,5	17	28
	32 5M 15 F	AF	32	50,93	49,79	Bm12	57	38	20,5	17	28
	36 5M 15 F	AF	36	57,30	56,15	Bm14	63	38	20,5	17	28
	40 5M 15 F	AF	40	63,66	62,52	Bm15	66	38	20,5	17	28
Alum	44 5M 15	A	44	70,03	68,89	-	-	38	20,5	-	30
	48 5M 15	A	48	76,39	75,25	-	-	40	20,5	-	30
	60 5M 15	A	60	95,49	94,35	-	-	50	20,5	-	30
	72 5M 15	B	72	114,59	113,45	-	-	50	20,5	-	30

HTD 5M 25 (rozeč 5 mm) pro šířku řemene 25 mm											
	Označení	Nákres	Zuby	Dp	De	Bočnice 1,5	Df	Dm	B1	B2	L
Ocel	12 5M 25 F	AF	12	19,09	17,95	Bm1	22	12	30,5	27	36
	14 5M 25 F	AF	14	22,28	21,14	Bm2	25	14	30,5	27	36
	15 5M 25 F	AF	15	23,87	22,73	Bm3	28	16	30,5	27	36
	16 5M 25 F	AF	16	25,46	24,32	Bm3	28	16	30,5	27	36
	18 5M 25 F	AF	18	28,65	27,50	Bm4	32	20	30,5	27	36
	20 5M 25 F	AF	20	31,83	30,69	Bm5	36	23	30,5	27	36
	21 5M 25 F	AF	21	33,42	32,28	Bm6	38	24	30,5	27	36
	22 5M 25 F	AF	22	35,01	33,87	Bm6	38	25	30,5	27	38
	24 5M 25 F	AF	24	38,20	37,05	Bm7	41	27	30,5	27	38
	26 5M 25 F	AF	26	41,38	40,24	Bm8	47	30	30,5	27	38
	28 5M 25 F	AF	28	44,56	43,42	Bm8	47	30	30,5	27	38
	30 5M 25 F	AF	30	47,75	46,60	Bm10	51	35	30,5	27	38
	32 5M 25 F	AF	32	50,93	49,79	Bm12	57	38	30,5	27	38
	36 5M 25 F	AF	36	57,30	56,15	Bm14	63	38	30,5	27	38
	40 5M 25 F	AF	40	63,66	62,52	Bm15	66	38	30,5	27	38
Alum	44 5M 25	A	44	70,03	68,89	-	-	38	30,5	-	38
	48 5M 25	A	48	76,39	75,25	-	-	40	30,5	-	40
	60 5M 25	A	60	95,49	94,35	-	-	50	30,5	-	40
	72 5M 25	B	72	114,59	113,45	-	-	50	30,5	-	40

Hodnoty Df a Dm se mohou měnit bez předběžného upozornění

HTD 8M 20 (rozteč 8 mm) pro šířku řemene 20 mm											
	Označení	Nákres	Zuby	Dp	De	Bočnice 1,5	Df	Dm	B1	B2	L
Ocel	22 8M 20 F	AF	22	56,02	54,65	Bm14	63	43	28	23	38
	24 8M 20 F	AF	24	61,12	59,75	Bm15	66	45	28	23	38
	26 8M 20 F	AF	26	66,21	64,84	Bm16	72	50	28	23	38
	28 8M 20 F	AF	28	71,30	70,08	Bm18	80	58	28	23	38
	30 8M 20 F	AF	30	76,39	75,13	Bm19	83	60	28	23	38
	32 8M 20 F	AF	32	81,49	80,16	Bm20	87	65	28	23	38
	34 8M 20 F	AF	34	86,58	85,22	Bm22	93	70	28	23	38
	36 8M 20 F	AF	36	91,67	90,30	Bm23	97	75	28	23	38
38 8M 20 F	AF	38	96,77	95,39	Bm24	105	80	28	23	38	
Litina	40 8M 20 F	AF	40	101,86	100,49	Bm25	106	85	28	23	38
	44 8M 20 F	AF	44	112,05	110,67	Bm27	118	95	28	23	38
	48 8M 20 F	AF	48	122,23	120,86	Bm29	127	95	28	23	38
	56 8M 20 F	AF	56	142,60	141,23	Bm36	152	115	28	23	38
	64 8M 20 F	BF	64	162,97	161,60	Bm38	168	90	28	23	40
	72 8M 20 F	BF	72	183,35	181,97	Bm41	194	95	28	23	40
	80 8M 20	B	80	203,72	202,35	-	-	100	28	-	40
	90 8M 20	B	90	229,18	227,81	-	-	100	28	-	40
	112 8M 20	C	112	285,21	283,83	-	-	100	28	-	40
	144 8M 20	C	144	366,69	365,32	-	-	100	28	-	40
	168 8M 20	C	168	427,81	426,44	-	-	100	28	-	40
192 8M 20	C	192	488,92	487,55	-	-	100	28	-	40	

HTD 8M 30 (rozteč 8 mm) pro šířku řemene 30 mm											
	Označení	Nákres	Zuby	Dp	De	Bočnice 1,5	Df	Dm	B1	B2	L
Ocel	22 8M 30 F	AF	22	56,02	54,65	Bm14	63	43	38	33	48
	24 8M 30 F	AF	24	61,12	59,75	Bm15	66	45	38	33	48
	26 8M 30 F	AF	26	66,21	64,84	Bm16	72	50	38	33	48
	28 8M 30 F	AF	28	71,30	70,08	Bm18	80	58	38	33	48
	30 8M 30 F	AF	30	76,39	75,13	Bm19	83	60	38	33	48
	32 8M 30 F	AF	32	81,49	80,16	Bm20	87	65	38	33	48
	34 8M 30 F	AF	34	86,58	85,22	Bm22	93	70	38	33	48
	36 8M 30 F	AF	36	91,67	90,30	Bm23	97	75	38	33	48
38 8M 30 F	AF	38	96,77	95,39	Bm24	105	80	38	33	48	
Litina	40 8M 30 F	AF	40	101,86	100,49	Bm25	106	85	38	33	48
	44 8M 30 F	AF	44	112,05	110,67	Bm27	118	95	38	33	48
	48 8M 30 F	AF	48	122,23	120,86	Bm29	127	95	38	33	48
	56 8M 30 F	AF	56	142,60	141,23	Bm36	152	115	38	33	48
	64 8M 30 F	BF	64	162,97	161,60	Bm38	168	90	38	33	50
	72 8M 30 F	BF	72	183,35	181,97	Bm41	194	95	38	33	50
	80 8M 30	B	80	203,72	202,35	-	-	100	38	-	50
	90 8M 30	B	90	229,18	227,81	-	-	100	38	-	50
	112 8M 30	C	112	285,21	283,83	-	-	100	38	-	50
	144 8M 30	C	144	366,69	365,32	-	-	100	38	-	50
	168 8M 30	C	168	427,81	426,44	-	-	100	38	-	50
192 8M 30	C	192	488,92	487,55	-	-	100	38	-	50	

Hodnoty Df a Dm se mohou měnit bez předběžného upozornění

# ŘEMENICE/UPÍNACÍ DESKY Ozubené řemenice profilu HTD

HTD 8M 50 (rozteč 8 mm) pro šířku řemene 50 mm											
	Označení	Nákres	Zuby	Dp	De	Bočnice 1,5	Df	Dm	B1	B2	L
Ocel	22 8M 50 F	AF	22	56,02	54,65	Bm14	63	43	60	55	70
	24 8M 50 F	AF	24	61,12	59,75	Bm15	66	45	60	55	70
	26 8M 50 F	AF	26	66,21	64,84	Bm16	72	50	60	55	70
	28 8M 50 F	AF	28	71,30	70,08	Bm18	80	58	60	55	70
	30 8M 50 F	AF	30	76,39	75,13	Bm19	83	60	60	55	70
	32 8M 50 F	AF	32	81,49	80,16	Bm20	87	65	60	55	70
	34 8M 50 F	AF	34	86,58	85,22	Bm22	93	70	60	55	70
	36 8M 50 F	AF	36	91,67	90,30	Bm23	97	75	60	55	70
Litina	38 8M 50 F	AF	38	96,77	95,39	Bm24	105	80	60	55	70
	40 8M 50 F	AF	40	101,86	100,49	Bm25	106	85	60	55	70
	44 8M 50 F	AF	44	112,05	110,67	Bm27	118	95	60	55	70
	48 8M 50 F	AF	48	122,23	120,86	Bm29	127	95	60	55	70
	56 8M 50 F	AF	56	142,60	141,23	Bm36	152	95	60	55	70
	64 8M 50 F	SBF	64	162,97	161,60	Bm38	168	100	60	55	60
	72 8M 50 F	SBF	72	183,35	181,97	Bm41	194	100	60	55	60
	80 8M 50	SB	80	203,72	202,35	-	-	110	60	-	60
	90 8M 50	SB	90	229,18	227,81	-	-	110	60	-	60
	112 8M 50	SC	112	285,21	283,83	-	-	110	60	-	60
	144 8M 50	SC	144	366,69	365,32	-	-	120	60	-	60
	168 8M 50	SC	168	427,81	426,44	-	-	120	60	-	60
192 8M 50	SC	192	488,92	487,55	-	-	130	60	-	60	

HTD 8M 85 (rozteč 8 mm) pro šířku řemene 85 mm											
	Označení	Nákres	Zuby	Dp	De	Bočnice 1,5	Df	Dm	B1	B2	L
Ocel	22 8M 85 F	AF	22	56,02	54,65	Bm14	63	43	95	90	105
	24 8M 85 F	AF	24	61,12	59,75	Bm15	66	45	95	90	105
	26 8M 85 F	AF	26	66,21	64,84	Bm16	72	50	95	90	105
	28 8M 85 F	AF	28	71,30	70,08	Bm18	80	58	95	90	105
	30 8M 85 F	AF	30	76,39	75,13	Bm19	83	60	95	90	105
	32 8M 85 F	AF	32	81,49	80,16	Bm20	87	65	95	90	105
	34 8M 85 F	AF	34	86,58	85,22	Bm22	93	70	95	90	105
	36 8M 85 F	AF	36	91,67	90,30	Bm23	97	75	95	90	105
Litina	38 8M 85 F	AF	38	96,77	95,39	Bm24	105	80	95	90	105
	40 8M 85 F	AF	40	101,86	100,49	Bm25	106	85	95	90	105
	44 8M 85 F	AF	44	112,05	110,67	Bm27	118	95	95	90	105
	48 8M 85 F	AF	48	122,23	120,86	Bm29	127	95	95	90	105
	56 8M 85 F	AF	56	142,60	141,23	Bm36	152	95	95	90	105
	64 8M 85 F	SBF	64	162,97	161,60	Bm38	168	100	95	90	95
	72 8M 85 F	SBF	72	183,35	181,97	Bm41	194	100	95	90	95
	80 8M 85	SB	80	203,72	202,35	-	-	110	95	-	95
	90 8M 85	SB	90	229,18	227,81	-	-	110	95	-	95
	112 8M 85	SC	112	285,21	283,83	-	-	110	95	-	95
	144 8M 85	SC	144	366,69	365,32	-	-	120	95	-	95
	168 8M 85	SC	168	427,81	426,44	-	-	120	95	-	95
192 8M 85	SC	192	488,92	487,55	-	-	130	95	-	95	

Hodnoty Df a Dm se mohou měnit bez předběžného upozornění

HTD 14M 40 (rozteč 14 mm) pro šířku řemene 40 mm rozteč											
	Označení	Nákres	Zuby	Dp	De	Bočnice 1,5	Df	Dm	B1	B2	L
Lítina	28 14M 40 F	AF	28	124,78	121,98	Bm43	136	85	54	46	69
	29 14M 40 F	AF	29	129,23	126,44	Bm44	140	100	54	46	69
	30 14M 40 F	AF	30	133,69	130,90	Bm45	145	100	54	46	69
	32 14M 40 F	AF	32	142,60	139,81	Bm46	155	100	54	46	69
	34 14M 40 F	AF	34	151,51	148,72	Bm47	162	110	54	46	69
	36 14M 40 F	AF	36	160,43	157,68	Bm49	176	115	54	46	69
	38 14M 40 F	AF	38	169,34	166,60	Bm50	182	125	54	46	69
	40 14M 40 F	AF	40	178,25	175,49	Bm51	191	135	54	46	69
	44 14M 40 F	AF	44	196,08	193,28	Bm55	210	155	54	46	69
	48 14M 40 F	AF	48	213,90	211,11	Bm57	225	170	54	46	69
	56 14M 40 F	BF	56	249,55	246,76	Bm61	255	135	54	46	69
	64 14M 40 F	BF	64	285,21	282,41	Bm63	290	135	54	46	69
	72 14M 40 F	BF	72	320,86	318,06	Bm69	335	135	54	46	69
	80 14M 40 F	BF	80	356,51	353,71	Bm110	370	135	54	46	69
	90 14M 40	C	90	401,07	398,28	-	-	135	54	-	69
	112 14M 40	C	112	499,11	496,32	-	-	135	54	-	69
	144 14M 40	C	144	641,71	638,92	-	-	135	54	-	69
	168 14M 40	C	168	748,66	745,87	-	-	135	54	-	69
192 14M 40	C	192	855,62	852,82	-	-	135	54	-	69	
216 14M 40	C	216	962,57	959,76	-	-	150	54	-	69	

HTD 14M 55 (rozteč 14 mm) pro šířku řemene 55 mm											
	Označení	Nákres	Zuby	Dp	De	Bočnice 1,5	Df	Dm	B1	B2	L
Lítina	28 14M 55 F	AF	28	124,78	121,98	Bm43	136	85	70	62	85
	29 14M 55 F	AF	29	129,23	126,44	Bm44	140	100	70	62	85
	30 14M 55 F	AF	30	133,69	130,90	Bm45	145	100	70	62	85
	32 14M 55 F	AF	32	142,60	139,81	Bm46	155	100	70	62	85
	34 14M 55 F	AF	34	151,51	148,72	Bm47	162	110	70	62	85
	36 14M 55 F	AF	36	160,43	157,68	Bm49	176	115	70	62	85
	38 14M 55 F	AF	38	169,34	166,60	Bm50	182	125	70	62	85
	40 14M 55 F	AF	40	178,25	175,49	Bm51	191	135	70	62	85
	44 14M 55 F	AF	44	196,08	193,28	Bm55	210	155	70	62	85
	48 14M 55 F	SBF	48	213,90	211,11	Bm57	225	135	70	62	70
	56 14M 55 F	SBF	56	249,55	246,76	Bm61	255	135	70	62	70
	64 14M 55 F	SBF	64	285,21	282,41	Bm63	290	135	70	62	70
	72 14M 55	SC	72	320,86	318,06	-	-	135	70	-	70
	80 14M 55	SC	80	356,51	353,71	-	-	135	70	-	70
	90 14M 55	SC	90	401,07	398,28	-	-	135	70	-	70
	112 14M 55	SC	112	499,11	496,32	-	-	135	70	-	70
	144 14M 55	SC	144	641,71	638,92	-	-	135	70	-	70
	168 14M 55	SC	168	748,66	745,87	-	-	135	70	-	70
192 14M 55	SC	192	855,62	852,82	-	-	135	70	-	70	
216 14M 55	SC	216	962,57	959,76	-	-	150	70	-	70	

Hodnoty Df a Dm se mohou měnit bez předběžného upozornění



# ŘEMENICE/UPÍNACÍ DESKY Ozubené řemenice profilu HTD

HTD 14M 85 (rozteč 14 mm) pro šířku řemene 85 mm											
	Označení	Nákres	Zuby	Dp	De	Bočnice 2,5	Df	Dm	B1	B2	L
Lítina	28 14M 85 F	AF	28	124,78	121,98	Bm43	136	85	102	94	117
	29 14M 85 F	AF	29	129,23	126,44	Bm44	140	100	102	94	117
	30 14M 85 F	AF	30	133,69	130,90	Bm45	145	100	102	94	117
	32 14M 85 F	AF	32	142,60	139,81	Bm46	155	100	102	94	117
	34 14M 85 F	AF	34	151,51	148,72	Bm47	162	110	102	94	117
	36 14M 85 F	AF	36	160,43	157,68	Bm49	176	115	102	94	117
	38 14M 85 F	AF	38	169,34	166,60	Bm50	182	125	102	94	117
	40 14M 85 F	AF	40	178,25	175,49	Bm51	191	135	102	94	117
	44 14M 85 F	AF	44	196,08	193,28	Bm55	210	155	102	94	117
	48 14M 85 F	AF	48	213,90	211,11	Bm57	225	170	102	94	117
	56 14M 85 F	SBF	56	249,55	246,76	Bm61	255	150	102	94	102
	64 14M 85 F	SBF	64	285,21	282,41	Bm63	290	150	102	94	102
	72 14M 85	SB	72	320,86	318,06	-	-	150	102	-	102
	80 14M 85	SC	80	356,51	353,71	-	-	150	102	-	102
	90 14M 85	SC	90	401,07	398,28	-	-	150	102	-	102
	112 14M 85	SC	112	499,11	496,32	-	-	150	102	-	102
	144 14M 85	SC	144	641,71	638,92	-	-	150	102	-	102
	168 14M 85	SC	168	748,66	745,87	-	-	150	102	-	102
192 14M 85	SC	192	855,62	852,82	-	-	165	102	-	102	
216 14M 85	SC	216	962,57	959,76	-	-	160	102	-	102	

HTD 14M 115 (rozteč 14 mm) pro šířku řemene 115 mm											
	Označení	Nákres	Zuby	Dp	De	Bočnice 2,5	Df	Dm	B1	B2	L
Lítina	28 14M 115 F	AF	28	124,78	121,98	Bm43	136	85	133	125	148
	29 14M 115 F	AF	29	129,23	126,44	Bm44	140	100	133	125	148
	30 14M 115 F	AF	30	133,69	130,90	Bm45	145	100	133	125	148
	32 14M 115 F	AF	32	142,60	139,81	Bm46	155	100	133	125	148
	34 14M 115 F	AF	34	151,51	148,72	Bm47	162	110	133	125	148
	36 14M 115 F	AF	36	160,43	157,68	Bm49	176	115	133	125	148
	38 14M 115 F	AF	38	169,34	166,60	Bm50	182	125	133	125	148
	40 14M 115 F	AF	40	178,25	175,49	Bm51	191	135	133	125	148
	44 14M 115 F	AF	44	196,08	193,28	Bm55	210	155	133	125	148
	48 14M 115 F	AF	48	213,90	211,11	Bm57	225	170	133	125	148
	56 14M 115 F	AF	56	249,55	246,76	Bm61	255	150	133	125	148
	64 14M 115 F	SBF	64	285,21	282,41	Bm63	290	150	133	125	133
	72 14M 115 F	SC	72	320,86	318,06	-	-	150	133	-	133
	80 14M 115	SC	80	356,51	353,71	-	-	150	133	-	133
	90 14M 115	SC	90	401,07	398,28	-	-	150	133	-	133
	112 14M 115	SC	112	499,11	496,32	-	-	150	133	-	133
	144 14M 115	SC	144	641,71	638,92	-	-	150	133	-	133
	168 14M 115	SC	168	748,66	745,87	-	-	150	133	-	133
192 14M 115	SC	192	855,62	852,82	-	-	150	133	-	133	
216 14M 115	SC	216	962,57	959,76	-	-	150	133	-	133	

Hodnoty Df a Dm se mohou měnit bez předběžného upozornění

HTD 14M 170 (rozteč 14 mm) pro šířku řemene 170 mm											
	Označení	Nákres	Zuby	Dp	De	Bočnice 2,5	Df	Dm	B1	B2	L
Litina	28 14M 170 F	AF	28	124,78	121,98	Bm43	136	85	187	179	202
	29 14M 170 F	AF	29	129,23	126,44	Bm44	140	100	187	179	202
	30 14M 170 F	AF	30	133,69	130,90	Bm45	145	100	187	179	202
	32 14M 170 F	AF	32	142,60	139,81	Bm46	155	100	187	179	202
	34 14M 170 F	AF	34	151,51	148,72	Bm47	162	110	187	179	202
	36 14M 170 F	AF	36	160,43	157,68	Bm49	176	115	187	179	202
	38 14M 170 F	AF	38	169,34	166,60	Bm50	182	125	187	179	202
	40 14M 170 F	AF	40	178,25	175,49	Bm51	191	135	187	179	202
	44 14M 170 F	AF	44	196,08	193,28	Bm55	210	155	187	179	202
	48 14M 170 F	AF	48	213,90	211,11	Bm57	225	170	187	179	202
	56 14M 170 F	AF	56	249,55	246,76	Bm61	255	150	187	179	202
	64 14M 170 F	AF	64	285,21	282,41	Bm63	290	150	187	179	202
	72 14M 170	SB	72	320,86	318,06	-	-	150	187	-	187
	80 14M 170	SB	80	356,51	353,71	-	-	150	187	-	187
	90 14M 170	SC	90	401,07	398,28	-	-	150	187	-	187
	112 14M 170	SC	112	499,11	496,32	-	-	150	187	-	187
	144 14M 170	SC	144	641,71	638,92	-	-	150	187	-	187
	168 14M 170	SC	168	748,66	745,87	-	-	150	187	-	187
192 14M 170	SC	192	855,62	852,82	-	-	165	187	-	187	
216 14M 170	SC	216	962,57	959,76	-	-	160	187	-	187	

Hodnoty Df a Dm se mohou měnit bez předběžného upozornění

HTD 8M 20 (rozeč 8 mm) pro šířku řemene 20 mm												
	Označení	Nákres	Zuby	Dp	De	Bočnice 1,5	Df	Dm	B1	B2	L	Taper Bush
Ocel	T22 8M 20 F	5F	22	56,02	54,65	Bm14	63	-	28	23	22	1008
	T24 8M 20 F	5F	24	61,12	59,75	Bm15	66	-	28	23	22	1108
	T26 8M 20 F	5F	26	66,21	64,84	Bm16	72	-	28	23	22	1108
	T28 8M 20 F	5F	28	71,30	70,08	Bm18	80	-	28	23	22	1108
	T30 8M 20 F	5F	30	76,39	75,13	Bm19	83	-	28	23	22	1108
	T32 8M 20 F	5F	32	81,49	80,16	Bm20	87	-	28	23	25	1610
	T34 8M 20 F	5F	34	86,58	85,22	Bm22	93	-	28	23	25	1610
	T36 8M 20 F	5F	36	91,67	90,30	Bm23	97	-	28	23	25	1610
	T38 8M 20 F	5F	38	96,77	95,39	Bm24	105	-	28	23	25	1610
Litina	T40 8M 20 F	5F	40	101,86	100,49	Bm25	106	-	28	23	25	1610
	T44 8M 20 F	8F	44	112,05	110,67	Bm28	121	87	28	23	32	2012
	T48 8M 20 F	8F	48	122,23	120,86	Bm29	127	95	28	23	32	2012
	T56 8M 20 F	8F	56	142,60	141,23	Bm36	152	105	28	23	32	2012
	T64 8M 20 F	8F	64	162,97	161,60	Bm38	168	105	28	23	32	2012
	T72 8M 20 F	8WF	72	183,35	181,97	Bm41	194	105	28	23	32	2012
	T80 8M 20	8W	80	203,72	202,35	-	-	105	28	-	32	2012
	T90 8M 20	8W	90	229,18	227,81	-	-	105	28	-	32	2012

HTD 8M 30 (rozeč 8 mm) pro šířku řemene 30 mm												
	Označení	Nákres	Zuby	Dp	De	Bočnice 1,5	Df	Dm	B1	B2	L	Taper Bush
Ocel	T22 8M 30 F	5F	22	56,02	54,65	Bm14	63	-	38	33	22	1008
	T24 8M 30 F	5F	24	61,12	59,75	Bm15	66	-	38	33	22	1108
	T26 8M 30 F	5F	26	66,21	64,84	Bm16	72	-	38	33	22	1108
	T28 8M 30 F	5F	28	71,30	70,08	Bm18	80	-	38	33	22	1108
	T30 8M 30 F	3F	30	76,39	75,13	Bm19	83	-	38	33	38	1615
	T32 8M 30 F	3F	32	81,49	80,16	Bm20	87	-	38	33	38	1615
	T34 8M 30 F	3F	34	86,58	85,22	Bm22	93	-	38	33	38	1615
	T36 8M 30 F	3F	36	91,67	90,30	Bm23	97	-	38	33	38	1615
	T38 8M 30 F	3F	38	96,77	95,39	Bm24	105	-	38	33	38	1615
Litina	T40 8M 30 F	3F	40	101,86	100,49	Bm25	106	-	38	33	38	1615
	T44 8M 30 F	4F	44	112,05	110,67	Bm28	121	-	38	33	32	2012
	T48 8M 30 F	4F	48	122,23	120,86	Bm29	127	-	38	33	32	2012
	T56 8M 30 F	4F	56	142,60	141,23	Bm36	152	-	38	33	32	2012
	T64 8M 30 F	8F	64	162,97	161,60	Bm38	168	130	38	33	45	2517
	T72 8M 30 F	8WF	72	183,35	181,97	Bm41	194	120	38	33	45	2517
	T80 8M 30	8W	80	203,72	202,35	-	-	120	38	-	45	2517
	T90 8M 30	8W	90	229,18	227,81	-	-	120	38	-	45	2517
	T112 8M 30	8A	112	285,21	283,83	-	-	120	38	-	45	2517
	T144 8M 30	8A	144	366,69	365,32	-	-	120	38	-	45	2517

HTD 8M 50 (rozeč 8 mm) pro šířku řemene 50 mm												
	Označení	Nákres	Zuby	Dp	De	Bočnice 1,5	Df	Dm	B1	B2	L	Taper Bush
Ocel	T28 8M 50 F	4F	28	71,30	70,08	Bm18	80	-	60	55	22	1108
	T30 8M 50 F	5F	30	76,39	75,13	Bm19	83	-	60	55	38	1615
	T32 8M 50 F	5F	32	81,49	80,16	Bm20	87	-	60	55	38	1615
	T34 8M 50 F	5F	34	86,58	85,22	Bm22	93	-	60	55	38	1615
	T36 8M 50 F	5F	36	91,67	90,30	Bm23	97	-	60	55	38	1615
	T38 8M 50 F	5F	38	96,77	95,39	Bm24	105	-	60	55	38	1615
Litina	T40 8M 50 F	4F	40	101,86	100,49	Bm25	106	-	60	55	32	2012
	T44 8M 50 F	4F	44	112,05	110,67	Bm28	121	-	60	55	32	2012
	T48 8M 50 F	4F	48	122,23	120,86	Bm29	127	-	60	55	32	2012
	T56 8M 50 F	4F	56	142,60	141,23	Bm36	152	-	60	55	45	2517
	T64 8M 50 F	4F	64	162,97	161,60	Bm38	168	-	60	55	45	2517
	T72 8M 50 F	9WF	72	183,35	181,97	Bm41	194	120	60	55	45	2517
	T80 8M 50	9W	80	203,72	202,35	-	-	145	60	-	51	3020
	T90 8M 50	9W	90	229,18	227,81	-	-	145	60	-	51	3020
	T112 8M 50	9A	112	285,21	283,83	-	-	145	60	-	51	3020
	T144 8M 50	9A	144	366,69	365,32	-	-	145	60	-	51	3020
	T168 8M 50	8A	168	427,81	426,44	-	-	145	60	-	76	3020
T192 8M 50	8A	192	488,92	487,55	-	-	145	60	-	76	3020	

Hodnoty Df a Dm se mohou měnit bez předběžného upozornění

HTD 8M 85 (rozeč 8 mm) pro šířku řemene 85 mm												
	Označení	Nákres	Zuby	Dp	De	Bočnice 1,5	Df	Dm	B1	B2	L	Taper Bush
Ocel	T34 8M 85 F	4F	34	86,58	85,22	Bm22	93	-	95	90	38	1615
	T36 8M 85 F	4F	36	91,67	90,30	Bm23	97	-	95	90	38	1615
	T38 8M 85 F	4F	38	96,77	95,39	Bm24	105	-	95	90	38	1615
Litina	T40 8M 85 F	4F	40	101,86	100,49	Bm25	106	-	95	90	32	2012
	T44 8M 85 F	4F	44	112,05	110,67	Bm28	121	-	95	90	32	2012
	T48 8M 85 F	4F	48	122,23	120,86	Bm29	127	-	95	90	45	2517
	T56 8M 85 F	4F	56	142,60	141,23	Bm36	152	-	95	90	45	2517
	T64 8M 85 F	4F	64	162,97	161,60	Bm38	168	-	95	90	51	2517
	T72 8M 85 F	4F	72	183,35	181,97	Bm41	194	120	95	90	51	3020
	T80 8M 85	9W	80	203,72	202,35	-	-	145	95	-	51	3020
	T90 8M 85	9W	90	229,18	227,81	-	-	145	95	-	51	3020
	T112 8M 85	9A	112	285,21	283,83	-	-	145	95	-	51	3020
	T144 8M 85	9A	144	366,69	365,32	-	-	145	95	-	76	3030
	T168 8M 85	9A	168	427,81	426,44	-	-	145	95	-	76	3030
	T192 8M 85	9A	192	488,92	487,55	-	-	145	95	-	76	3030

HTD 14M 40 (rozeč 14 mm) pro šířku řemene 40 mm												
	Označení	Nákres	Zuby	Dp	De	Bočnice 1,5	Df	Dm	B1	B2	L	Taper Bush
Litina	T28 14M 40 F	4F	28	124,78	121,98	Bm43	136	-	54	46	32	2012
	T29 14M 40 F	4F	29	129,23	126,44	Bm44	140	-	54	46	32	2012
	T30 14M 40 F	4F	30	133,69	130,90	Bm45	145	-	54	46	32	2012
	T32 14M 40 F	4F	32	142,60	139,81	Bm46	155	-	54	46	32	2012
	T34 14M 40 F	4F	34	151,51	148,72	Bm47	162	-	54	46	45	2517
	T36 14M 40 F	4F	36	160,43	157,68	Bm49	176	-	54	46	45	2517
	T38 14M 40 F	4F	38	169,34	166,60	Bm50	182	-	54	46	45	2517
	T40 14M 40 F	4F	40	178,25	175,49	Bm51	191	-	54	46	45	2517
	T44 14M 40 F	4F	44	196,08	193,28	Bm55	210	-	54	46	51	3020
	T48 14M 40 F	4F	48	213,90	211,11	Bm57	225	-	54	46	51	3020
	T56 14M 40 F	9WF	56	249,55	246,76	Bm61	255	145	54	46	51	3020
	T64 14M 40 F	9AF	64	285,21	282,41	Bm63	290	145	54	46	51	3020
	T72 14M 40	9A	72	320,86	318,06	-	-	145	54	-	51	3020
	T80 14M 40	9A	80	356,51	353,71	-	-	145	54	-	51	3020
	T90 14M 40	9A	90	401,07	398,28	-	-	145	54	-	51	3020
	T112 14M 40	9A	112	499,11	496,32	-	-	140	54	-	51	3020
	T144 14M 40	9A	144	641,71	638,92	-	-	140	54	-	51	3020
	T168 14M 40	8A	168	748,66	745,87	-	-	145	54	-	89	3535
	T192 14M 40	8A	192	855,62	852,82	-	-	155	54	-	89	3535
	T216 14M 40	8A	216	962,57	959,76	-	-	145	54	-	89	3535

HTD 14M 55 (rozeč 14 mm) pro šířku řemene 55 mm												
	Označení	Nákres	Zuby	Dp	De	Bočnice 1,5	Df	Dm	B1	B2	L	Taper Bush
Litina	T28 14M 55 F	4F	28	124,78	121,98	Bm43	136	-	70	62	32	2012
	T29 14M 55 F	4F	29	129,23	126,44	Bm44	140	-	70	62	32	2012
	T30 14M 55 F	4F	30	133,69	130,90	Bm45	145	-	70	62	45	2517
	T32 14M 55 F	4F	32	142,60	139,81	Bm46	155	-	70	62	45	2517
	T34 14M 55 F	4F	34	151,51	148,72	Bm47	162	-	70	62	45	2517
	T36 14M 55 F	4F	36	160,43	157,68	Bm49	176	-	70	62	45	2517
	T38 14M 55 F	4F	38	169,34	166,60	Bm50	182	-	70	62	45	2517
	T40 14M 55 F	4F	40	178,25	175,49	Bm51	191	-	70	62	45	2517
	T44 14M 55 F	4F	44	196,08	193,28	Bm55	210	-	70	62	51	3020
	T48 14M 55 F	4F	48	213,90	211,11	Bm57	225	-	70	62	51	3020
	T56 14M 55 F	9WF	56	249,55	246,76	Bm61	255	145	70	62	51	3020
	T64 14M 55 F	9WF	64	285,21	282,41	Bm63	290	170	70	62	51	3020
	T72 14M 55	9W	72	320,86	318,06	-	-	170	70	-	51	3020
	T80 14M 55	9W	80	356,51	353,71	-	-	170	70	-	51	3020
	T90 14M 55	9A	90	401,07	398,28	-	-	160	70	-	51	3020
	T112 14M 55	9A	112	499,11	496,32	-	-	160	70	-	51	3020
	T144 14M 55	9A	144	641,71	638,92	-	-	160	70	-	51	3020
	T168 14M 55	8A	168	748,66	745,87	-	-	160	70	-	89	3535
	T192 14M 55	8A	192	855,62	852,82	-	-	160	70	-	89	3535
	T216 14M 55	8A	216	962,57	959,76	-	-	160	70	-	89	3535

Hodnoty Df a Dm se mohou měnit bez předběžného upozornění

HTD 14M 85 (rozteč 14 mm) pro šířku řemene 85 mm												
	Označení	Nákres	Zuby	Dp	De	Bočnice 1,5	Df	Dm	B1	B2	L	Taper Bush
Litina	T28 14M 85 F	4F	28	124,78	121,98	Bm44	140	-	102	94	45	2517
	T29 14M 85 F	4F	29	129,23	126,44	Bm44	140	-	102	94	45	2517
	T30 14M 85 F	4F	30	133,69	130,90	Bm45	145	-	102	94	45	2517
	T32 14M 85 F	4F	32	142,60	139,81	Bm46	155	-	102	94	45	2517
	T34 14M 85 F	4F	34	151,51	148,72	Bm47	162	-	102	94	45	2517
	T36 14M 85 F	4F	36	160,43	157,68	Bm49	176	-	102	94	51	3020
	T38 14M 85 F	4F	38	169,34	166,60	Bm50	182	-	102	94	51	3020
	T40 14M 85 F	4F	40	178,25	175,49	Bm51	191	-	102	94	51	3020
	T44 14M 85 F	4F	44	196,08	193,28	Bm55	210	-	102	94	76	3030
	T48 14M 85 F	4F	48	213,90	211,11	Bm57	225	-	102	94	76	3030
	T56 14M 85 F	4F	56	249,55	246,76	Bm61	255	-	102	94	89	3535
	T64 14M 85 F	9WF	64	285,21	282,41	Bm63	290	170	102	94	89	3535
	T72 14M 85	9A	72	320,86	318,06	-	-	170	102	-	89	3535
	T80 14M 85	9A	80	356,51	353,71	-	-	170	102	-	89	3535
	T90 14M 85	9A	90	401,07	398,28	-	-	160	102	-	89	3535
	T112 14M 85	9A	112	499,11	496,32	-	-	160	102	-	89	3535
	T144 14M 85	9A	144	641,71	638,92	-	-	160	102	-	89	3535
	T168 14M 85	9A	168	748,66	745,87	-	-	160	102	-	89	3535
	T192 14M 85	9A	192	855,62	852,82	-	-	190	102	-	102	4040
	T216 14M 85	8A	216	962,57	959,76	-	-	205	102	-	114	4545

HTD 14M 115 (rozteč 14 mm) pro šířku řemene 115 mm												
	Označení	Nákres	Zuby	Dp	De	Bočnice 1,5	Df	Dm	B1	B2	L	Taper Bush
Litina	T29 14M 115 F	4F	29	129,23	126,44	Bm44	140	-	133	125	45	2517
	T30 14M 115 F	4F	30	133,69	130,90	Bm45	145	-	133	125	45	2517
	T32 14M 115 F	4F	32	142,60	139,81	Bm46	155	-	133	125	45	2517
	T34 14M 115 F	4F	34	151,51	148,72	Bm47	162	-	133	125	45	2517
	T36 14M 115 F	4F	36	160,43	157,68	Bm49	176	-	133	125	51	3020
	T38 14M 115 F	4F	38	169,34	166,60	Bm50	182	-	133	125	51	3020
	T40 14M 115 F	4F	40	178,25	175,49	Bm51	191	-	133	125	51	3020
	T44 14M 115 F	4F	44	196,08	193,28	Bm55	210	-	133	125	76	3030
	T48 14M 115 F	4F	48	213,90	211,11	Bm57	225	-	133	125	76	3030
	T56 14M 115 F	4F	56	249,55	246,76	Bm61	255	-	133	125	89	3535
	T64 14M 115 F	9WF	64	285,21	282,41	Bm63	290	170	133	125	89	3535
	T72 14M 115 F	9A	72	320,86	318,06	-	-	170	133	-	89	3535
	T80 14M 115	9A	80	356,51	353,71	-	-	170	133	-	89	3535
	T90 14M 115	9A	90	401,07	398,28	-	-	190	133	-	102	3535
	T112 14M 115	9A	112	499,11	496,32	-	-	190	133	-	102	3535
	T144 14M 115	9A	144	641,71	638,92	-	-	205	133	-	114	3535
	T168 14M 115	9A	168	748,66	745,87	-	-	205	133	-	114	4545
	T192 14M 115	9A	192	855,62	852,82	-	-	205	133	-	114	4545
	T216 14M 115	9A	216	962,57	959,76	-	-	240	133	-	127	5050

HTD 14M 170 (rozteč 14 mm) pro šířku řemene 170 mm												
	Označení	Nákres	Zuby	Dp	De	Bočnice 1,5	Df	Dm	B1	B2	L	Taper Bush
Litina	T38 14M 170 F	4F	38	169,34	166,60	Bm50	182	-	187	179	76	3030
	T40 14M 170 F	4F	40	178,25	175,49	Bm51	191	-	187	179	76	3030
	T44 14M 170 F	4F	44	196,08	193,28	Bm55	210	-	187	179	89	3535
	T48 14M 170 F	4F	48	213,90	211,11	Bm57	225	-	187	179	89	3535
	T56 14M 170 F	4F	56	249,55	246,76	Bm61	255	-	187	179	89	3535
	T64 14M 170 F	9WF	64	285,21	282,41	Bm63	290	190	187	179	102	4040
	T72 14M 170	9W	72	320,86	318,06	-	-	190	187	-	102	4040
	T80 14M 170	9W	80	356,51	353,71	-	-	190	187	-	102	4040
	T90 14M 170	9A	90	401,07	398,28	-	-	190	187	-	102	4040
	T112 14M 170	9A	112	499,11	496,32	-	-	240	187	-	127	5050
	T144 14M 170	9A	144	641,71	638,92	-	-	240	187	-	127	5050
	T168 14M 170	9A	168	748,66	745,87	-	-	240	187	-	127	5050
	T192 14M 170	9A	192	855,62	852,82	-	-	240	187	-	127	5050
	T216 14M 170	9A	216	962,57	959,76	-	-	240	187	-	127	5050

Hodnoty Df a Dm se mohou měnit bez předběžného upozornění





# OZUBENÉ TYČE

Celkové ozubení  $L_u=L$

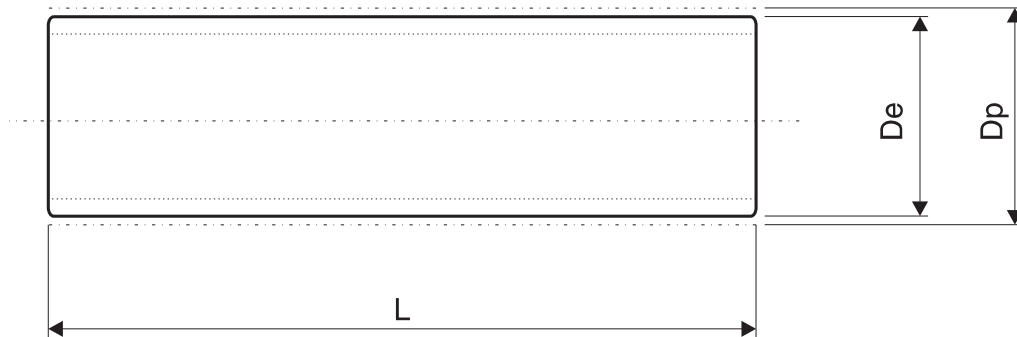

T2,5 (rozteč 2,5 mm)					
	Označení	Zuby	Dp	De	L
Hliník	T2,5-10	10	7,96	7,44	75
	T2,5-12	12	9,55	9,03	75
	T2,5-13	13	10,35	9,83	75
	T2,5-14	14	11,14	10,62	75
	T2,5-15	15	11,94	11,42	75
	T2,5-16	16	12,73	12,21	75
	T2,5-17	17	13,53	13,01	75
	T2,5-18	18	14,32	13,80	75
	T2,5-19	19	15,12	14,60	120
	T2,5-20	20	15,92	15,40	120
	T2,5-21	21	16,71	16,19	120
	T2,5-22	22	17,51	16,99	140
	T2,5-23	23	18,30	17,78	140
	T2,5-24	24	19,10	18,58	140
	T2,5-25	25	19,89	19,37	140
	T2,5-26	26	20,69	20,17	140
	T2,5-27	27	21,49	20,97	140
	T2,5-28	28	22,28	21,76	140
	T2,5-29	29	23,08	22,56	140
	T2,5-30	30	23,87	23,35	140
	T2,5-32	32	25,46	24,95	140
	T2,5-34	34	27,06	26,54	140
	T2,5-35	35	27,85	27,33	140
	T2,5-36	36	28,65	28,13	140
	T2,5-38	38	30,24	29,72	140
	T2,5-40	40	31,83	31,31	140
	T2,5-42	42	33,42	32,90	140
	T2,5-44	44	35,01	34,50	140
	T2,5-45	45	35,81	35,29	140
	T2,5-48	48	38,20	37,68	140
T2,5-50	50	39,79	39,27	160	
T2,5-60	60	47,75	47,23	160	
T2,5-65	65	51,73	51,21	160	
T2,5-70	70	55,70	55,19	160	
T2,5-72	72	57,30	56,78	160	
T2,5-90	90	71,62	71,10	160	
T2,5-100	100	79,58	79,06	160	

T5 (rozteč 5 mm)					
	Označení	Zuby	Dp	De	L
Hliník	T5-10	10	15,92	15,09	140
	T5-11	11	17,51	16,68	140
	T5-12	12	19,10	18,27	140
	T5-13	13	20,69	19,86	140
	T5-14	14	22,28	21,45	140
	T5-15	15	23,87	23,04	140
	T5-16	16	25,46	24,64	140
	T5-17	17	27,06	26,23	140
	T5-18	18	28,65	27,82	140
	T5-19	19	30,24	29,41	140
	T5-20	20	31,83	31,00	160
	T5-21	21	33,42	32,59	160
	T5-22	22	35,01	34,19	160
	T5-23	23	36,61	35,78	160
	T5-24	24	38,20	37,37	160
	T5-25	25	39,79	38,96	160
	T5-26	26	41,38	40,55	160
	T5-27	27	42,97	42,14	160
	T5-28	28	44,56	43,73	160
	T5-29	29	46,15	45,33	160
	T5-30	30	47,75	46,92	160
	T5-32	32	50,93	50,10	160
	T5-34	34	54,11	53,28	160
	T5-35	35	55,70	54,88	160
	T5-36	36	57,30	56,47	160
	T5-37	37	58,89	58,06	160
	T5-38	38	60,48	59,65	160
	T5-40	40	63,66	62,83	160
	T5-42	42	66,85	66,02	160
	T5-44	44	70,03	69,20	160
T5-45	45	71,62	70,79	160	
T5-46	46	73,21	72,38	160	
T5-48	48	76,39	75,57	160	
T5-50	50	79,58	78,75	160	
T5-60	60	95,49	94,67	160	
T5-64	64	101,86	101,03	160	
T5-72	72	114,59	113,76	160	
T5-80	80	127,32	126,50	160	
T5-90	90	143,24	142,41	160	
T5-100	100	159,15	158,33	160	

T10 (rozteč 10 mm)					
	Označení	Zuby	Dp	De	L
Hliník	T10-10	10	31,83	29,98	140
	T10-11	11	35,01	33,17	140
	T10-12	12	38,20	36,35	140
	T10-13	13	41,38	39,53	140
	T10-14	14	44,56	42,71	160
	T10-15	15	47,75	45,90	160
	T10-16	16	50,93	49,08	160
	T10-17	17	54,11	52,26	160
	T10-18	18	57,30	55,45	160
	T10-19	19	60,48	58,63	160
	T10-20	20	63,66	61,81	160
	T10-21	21	66,85	65,00	160
	T10-22	22	70,03	68,18	160
	T10-23	23	73,21	71,36	160
	T10-24	24	76,39	74,55	160

T10 (rozteč 10 mm)					
	Označení	Zuby	Dp	De	L
Hliník	T10-25	25	79,58	77,73	160
	T10-26	26	82,76	80,91	160
	T10-27	27	85,94	84,10	160
	T10-28	28	89,13	87,28	160
	T10-30	29	95,49	93,65	160
	T10-32	32	101,86	100,01	160
	T10-34	34	108,23	106,38	160
	T10-36	36	114,59	112,74	160
	T10-38	38	120,96	119,11	160
	T10-40	40	127,32	125,48	160
	T10-45	45	143,24	141,39	160
	T10-48	48	152,79	150,94	160
	T10-60	60	190,99	189,14	160
	T10-72	72	229,18	227,34	160

# ŘEMENICE/UPÍNACÍ DESKY

AT5 (rozteč 5 mm)					
	Označení	Zuby	Dp	De	L
Hliník	AT5-12	12	19,10	17,87	140
	AT5-13	13	20,69	19,46	140
	AT5-14	14	22,28	21,05	140
	AT5-15	15	23,87	22,64	140
	AT5-16	16	25,46	24,24	140
	AT5-17	17	27,06	25,83	140
	AT5-18	18	28,65	27,42	140
	AT5-19	19	30,24	29,01	140
	AT5-20	20	31,83	30,60	160
	AT5-21	21	33,42	32,19	160
	AT5-22	22	35,01	33,79	160
	AT5-23	23	36,61	35,38	160
	AT5-24	24	38,20	36,97	160
	AT5-25	25	39,79	38,56	160
	AT5-26	26	41,38	40,15	160
	AT5-27	27	42,97	41,74	160
	AT5-28	28	44,56	43,33	160
	AT5-29	29	46,15	44,93	160
	AT5-30	30	47,75	46,52	160
	AT5-31	31	49,34	48,11	160
	AT5-32	32	50,93	49,70	160
	AT5-34	34	54,11	52,88	160
	AT5-35	35	55,70	54,48	160
	AT5-36	36	57,30	56,07	160
	AT5-38	38	60,48	59,25	160
	AT5-40	40	63,66	62,43	160
	AT5-42	42	66,85	65,62	160
	AT5-44	44	70,03	68,80	160
	AT5-45	45	71,62	70,39	160
	AT5-46	46	73,21	71,98	160
	AT5-48	48	76,39	75,17	160
	AT5-50	50	79,58	78,35	160
AT5-60	60	95,49	94,27	160	
AT5-64	64	101,86	100,63	160	
AT5-72	72	114,59	113,36	160	

AT10 (rozteč 10 mm)					
	Označení	Zuby	Dp	De	L
Hliník	AT10-15	15	47,75	45,90	160
	AT10-16	16	50,93	49,08	160
	AT10-17	17	54,11	52,26	160
	AT10-18	18	57,30	55,45	160
	AT10-19	19	60,48	58,63	160
	AT10-20	20	63,66	61,81	160
	AT10-21	21	66,85	65,00	160
	AT10-22	22	70,03	68,18	160
	AT10-23	23	73,21	71,36	160
	AT10-24	24	76,39	74,55	160
	AT10-25	25	79,58	77,73	160
	AT10-26	26	82,76	80,91	160
	AT10-27	27	85,94	84,10	160
	AT10-28	28	89,13	87,28	160
	AT10-29	29	92,31	90,46	160
	AT10-30	30	95,49	93,65	160
	AT10-32	32	101,86	100,01	160
	AT10-34	34	108,23	106,38	160
	AT10-35	35	111,41	109,56	160
	AT10-36	36	114,59	112,74	160
	AT10-38	38	120,96	119,11	160
	AT10-40	40	127,32	125,48	160
	AT10-42	42	133,69	131,84	160
	AT10-44	44	140,06	138,21	160
	AT10-45	45	143,24	141,39	160
	AT10-48	48	152,79	150,94	160
	AT10-52	52	165,53	163,68	160
	AT10-60	60	190,99	189,14	160

3M (rozteč 3 mm)					
	Označení	Zuby	Dp	De	L
Hliník	3M-10	10	9,55	8,79	100
	3M-11	11	10,50	9,74	100
	3M-12	12	11,46	10,70	120
	3M-13	13	12,41	11,65	120
	3M-14	14	13,37	12,61	120
	3M-15	15	14,32	13,56	120
	3M-16	16	15,28	14,52	160
	3M-17	17	16,23	15,47	160
	3M-18	18	17,19	16,43	160
	3M-19	19	18,14	17,38	160
	3M-20	20	19,10	18,34	160
	3M-21	21	20,05	19,29	160
	3M-22	22	21,01	20,25	160
	3M-23	23	21,96	21,20	160
	3M-24	24	22,92	22,16	160
	3M-25	25	23,87	23,11	160
	3M-26	26	24,83	24,07	160
	3M-28	28	26,74	25,98	160
	3M-30	30	28,65	27,89	200
	3M-32	32	30,56	29,80	200
	3M-34	34	32,47	31,71	200
	3M-36	36	34,38	33,62	200
	3M-38	38	36,29	35,53	200
	3M-40	40	38,20	37,44	200
3M-42	42	40,11	39,35	200	
3M-45	45	42,97	42,21	200	
3M-48	48	45,84	45,08	200	
3M-60	60	57,30	56,54	200	
3M-72	72	68,75	68,00	200	

5M (rozteč 5 mm)					
	Označení	Zuby	Dp	De	L
Hliník - Ocel	5M-12	12	19,10	17,96	160
	5M-13	13	20,69	19,55	160
	5M-14	14	22,28	21,14	200
	5M-15	15	23,87	22,73	200
	5M-16	16	25,46	24,33	200
	5M-17	17	27,06	25,92	200
	5M-18	18	28,65	27,51	200
	5M-19	19	30,24	29,10	200
	5M-20	20	31,83	30,69	200
	5M-21	21	33,42	32,28	200
	5M-22	22	35,01	33,88	200
	5M-23	23	35,61	35,47	200
	5M-24	24	38,20	37,06	200
	5M-26	26	41,38	40,24	200
	5M-27	27	42,97	41,83	200
	5M-28	28	44,56	43,42	200
	5M-30	30	47,75	46,61	200
	5M-32	32	50,93	49,79	200
	5M-34	34	54,11	52,97	200
	5M-36	36	57,30	56,16	200
	5M-38	38	60,48	59,34	200
	5M-40	40	63,66	62,52	200
	5M-42	42	66,85	65,71	200
	5M-44	44	70,03	68,89	200
5M-45	45	71,62	70,48	200	
5M-48	48	76,39	75,26	200	
5M-50	50	79,58	78,44	200	
5M-60	60	95,49	94,36	200	
5M-72	72	114,59	113,45	200	

8M (rozteč 8 mm)					
	Označení	Zuby	Dp	De	L
Hliník - Ocel	8M-18	18	45,84	44,47	200
	8M-19	19	48,38	47,01	200
	8M-20	20	50,93	49,56	200
	8M-21	21	53,48	52,11	200
	8M-22	22	56,02	54,65	200
	8M-23	23	58,57	57,20	200
	8M-24	24	61,12	59,75	200
	8M-25	25	63,66	62,29	200
	8M-26	26	66,21	64,84	200
	8M-27	27	68,75	67,39	200
	8M-28	28	71,30	70,08	200
	8M-29	29	73,85	72,48	200
	8M-30	30	76,39	75,03	200
	8M-32	32	81,49	80,12	200
	8M-34	34	86,58	85,21	200
	8M-35	35	89,13	87,76	200
	8M-36	36	91,67	90,31	200
8M-38	38	96,77	95,40	200	
8M-40	40	101,86	100,49	200	



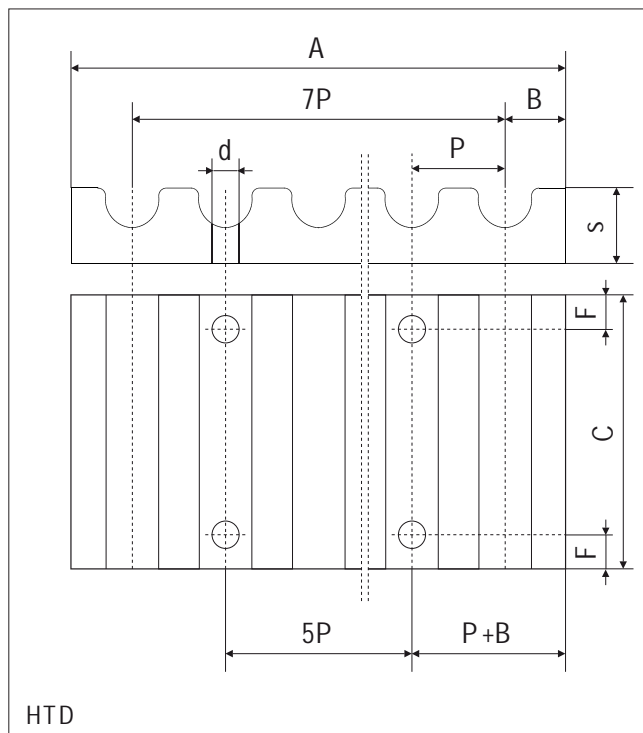
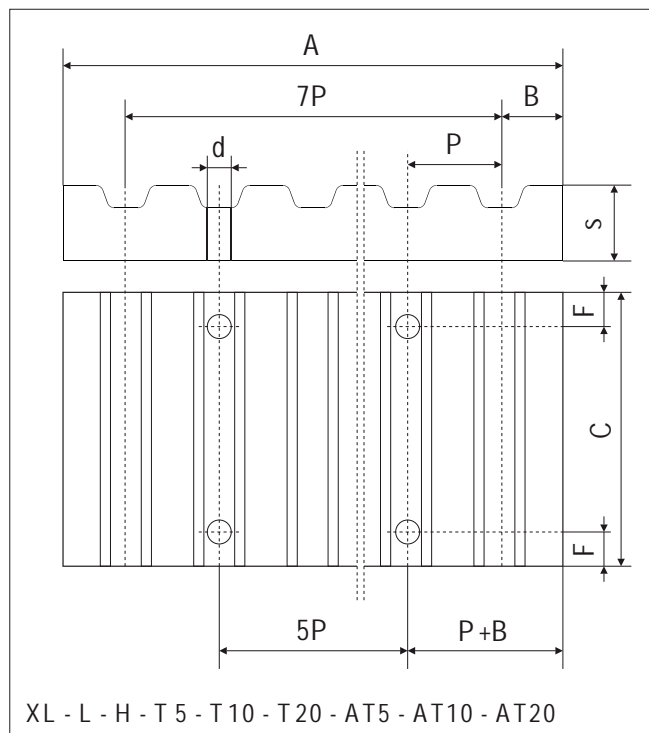

**Příklad objednáacího kódu:  
upínací deska pro profil AT10 a šířku řemene 25 mm**

**Upínací desky pro řemeny palcových profilů**

Hliník	Rozteč	F	d	B	A	S	Šířka řemene (palce)								
							025	037	050	075	100	150	200	300	400
							C								
XL	6	5,5	3,5	42,5	8	25,5	28,5	32	38	45					
L	8	9	5	76,6	15		36	39	45	51,5	64	77			
H	10	11	9	106,9	22			45	51	57,5	70	83	108	134	

**Upínací desky pro řemeny profilu HTD**

Hliník	Rozteč	F	d	B	A	S	Šířka řemene (mm)												
							6	9	10	15	20	25	30	40	50	55	85	115	170
							C												
5M	6	5,5	3,25	41,5	8	25	28		34		44								
8M	8	9	5	66	15			35	40	45		55		75		110			
14M	10	11	9	116	22						56		71		86	116	146	201	

**Upínací desky pro řemeny metrických profilů (T, AT)**

Hliník	Rozteč	F	d	B	A	S	Šířka řemene (mm)								
							6	10	16	20	25	32	50	75	100
							C								
T5 AT5	6	5,5	3,25	41,65	8	25	29	35	39	44	51	69			
T 10 AT10	8	9	5	80	15		35	41		50	57	75	100	125	
T20 AT20	10	11	10	160	20					56	63	81	106	132	

Upínací pouzdra Taper Bush										
	Typ	Otvory Ø [mm]	A	B	D	č.	Šrouby Ø	Délka šroubů	Pero	Moment utažení [daNM]
Litina	1008	10 11 12 14 16 18 19 20 22 24* 25*	35,2	22	33,7	2	1/4"	1/2"	3	0,6
	1108	10 11 12 14 16 18 19 20 22 24 25 28*	38,8	22	36,9	2	1/4"	1/2"	3	0,6
	1210	11 12 14 16 18 19 20 22 24 25 25 30 32	47,6	25	44,5	2	3/8"	5/8"	4	2
	1610	14 16 18 19 20 22 24 25 28 30 32 35 38 40 42*	57,2	25	54	2	3/8"	5/8"	4	2
	1615	14 16 18 19 20 22 24 25 28 30 32 35 38 40* 42*	57,2	38	54	2	3/8"	5/8"	4	2
	2012	14 16 18 19 20 22 24 25 28 30 32 35 38 40 42 45 48 50	69,9	32	66,7	2	7/16"	7/8"	6	3
	2517	16 18 19 20 22 24 25 28 30 32 40 42 45 48 50 55 60 65	85,7	45	82,5	2	1/2"	1"	6	5
	3020	25 28 30 32 38 40 42 45 48 50 55 60 65 70 75	108	51	101,6	2	5/8"	11/4"	8	9
	3030	35 38 40 42 45 48 50 55 60 65 70 75	108	76	101,6	2	5/8"	11/4"	8	9
	3525	35 38 40 42 45 48 50 55 60 65 70 75 80 85 90 95	127	65	122,7	3	1/2"	11/2"	10	10
	3535	35 38 40 42 45 48 50 55 60 65 70 75 80 85 90	127	89	122,7	3	1/2"	11/2"	10	10
	4030	40 42 45 48 50 55 60 65 70 75 80 85 90 95 100 105 110	146	78	140,7	3	5/8"	13/4"	14	19
	4040	40 42 45 48 50 55 60 65 70 75 80 85 90 95 100	146	101,6	140,7	3	5/8"	13/4"	14	19
	4545	55 60 65 70 75 80 85 90 95 100 105 110	162	114,3	155,7	3	3/4"	2"	14	24
	5050	70 75 80 85 90 95 100 105 110 115 120 125	177,8	127	170,7	3	7/8"	21/4"	14	36

\* Otvory s úzkou drážkou dle DIN 6556

## Drážky pro pero pro upínací pouzdra Taper Bush

	Ø otvoru pouzdra	Drážka pro pero	
		b	12
Litina	10 - 12	4	1,8
	13 - 17	5	2,3
	18 - 22	6	2,8
	23 - 30	8	3,3
	31 - 38	10	3,3
	39 - 44	12	3,3
	45 - 50	14	3,8
	51 - 58	16	4,3
	59 - 65	18	4,4
	66 - 75	20	4,9
	76 - 85	22	5,4
	86 - 95	25	5,4
	96 - 110	28	6,4
111 - 130	32	7,4	

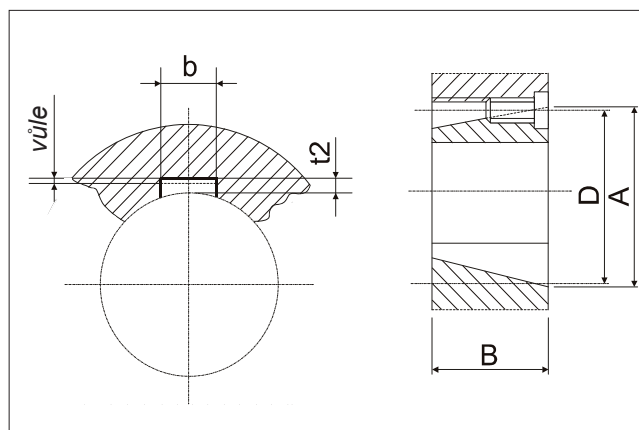

Důležité:  
V průběhu montáže je třeba dbát na maximální možnou míru odstranění nečistot mezi perem a drážkou.

Pozn.: Tvar, rozměry a tolerance mohou být změněny bez dalšího upozornění

Zuby	Profil													Zuby
	MXL	XL	L	H	XH	HTD3	HTD5	HTD8	HTD14	T2,5	T/AT5	T/AT10	T/AT20	
10	-	Bm1	Bm5	-	-	Bm73	-	-	-	-	Bm0	Bm5	-	10
11	-	Bm1	Bm7	-	-	Bm73	-	-	-	-	Bm1	Bm6	-	11
12	Bm73	Bm2	Bm7	Bm12	-	Bm74	Bm1	-	-	Bm73	Bm1	Bm7	-	12
13	Bm73	Bm2	Bm8	Bm13	-	Bm74	Bm2	-	-	Bm73	Bm2	Bm8	-	13
14	Bm73	Bm3	Bm8	Bm14	-	Bm75	Bm2	-	-	Bm74	Bm2	Bm9	-	14
15	Bm73	Bm3	Bm10	Bm15	-	Bm75	Bm3	-	-	Bm74	Bm3	Bm10	Bm106	15
16	Bm74	Bm3	Bm12	Bm16	-	Bm0	Bm3	-	-	Bm75	Bm4	Bm11	Bm107	16
17	Bm74	Bm5	Bm12	Bm17	-	Bm0	Bm4	-	-	Bm75	Bm4	Bm12	Bm107	17
18	Bm74	Bm5	Bm14	Bm18	Bm43	Bm1	Bm4	Bm9	-	Bm75	Bm4	Bm13	Bm92	18
19	Bm75	Bm5	Bm14	Bm19	Bm44	Bm1	Bm4	Bm10	-	Bm0	Bm5	Bm15	Bm108	19
20	Bm75	Bm7	Bm15	Bm20	Bm46	Bm2	Bm5	Bm11	-	Bm1	Bm5	Bm15	Bm43	20
21	Bm75	Bm7	Bm16	Bm21	Bm46	Bm2	Bm6	Bm12	-	Bm1	Bm6	Bm16	Bm43	21
22	Bm75	Bm7	Bm17	Bm23	Bm47	Bm2	Bm6	Bm14	-	Bm1	Bm6	Bm17	Bm45	22
23	Bm0	Bm8	Bm18	Bm23	Bm48	Bm2	Bm7	Bm14	Bm107	Bm1	Bm7	Bm18	Bm45	23
24	Bm0	Bm8	Bm18	Bm24	Bm49	Bm3	Bm7	Bm15	Bm90	Bm1	Bm7	Bm19	Bm47	24
25	Bm0	Bm8	Bm19	Bm24	Bm50	Bm3	Bm8	Bm15	Bm90	Bm2	Bm8	Bm19	Bm48	25
26	Bm1	Bm8	Bm20	Bm26	Bm51	Bm3	Bm8	Bm16	Bm92	Bm2	Bm8	Bm20	Bm48	26
27	Bm1	Bm9	Bm20	Bm27	Bm52	Bm4	Bm8	Bm16	Bm92	Bm2	Bm9	Bm21	Bm49	27
28	Bm1	Bm10	Bm21	Bm28	Bm55	Bm4	Bm8	Bm18	Bm43	Bm2	Bm9	Bm22	Bm50	28
29	Bm1	Bm10	Bm22	Bm28	Bm56	Bm4	Bm10	Bm18	Bm44	Bm2	Bm10	Bm23	Bm52	29
30	Bm2	Bm12	Bm23	Bm29	Bm57	Bm4	Bm10	Bm19	Bm45	Bm3	Bm10	Bm23	Bm52	30
31	Bm2	Bm12	Bm24	Bm31	Bm58	Bm5	Bm11	Bm19	Bm45	Bm4	Bm11	Bm24	Bm52	31
32	Bm2	Bm12	Bm24	Bm32	Bm60	Bm5	Bm12	Bm20	Bm46	Bm4	Bm11	Bm25	Bm55	32
33	Bm2	Bm12	Bm24	Bm32	Bm60	Bm5	Bm12	Bm20	Bm46	Bm4	Bm12	Bm26	Bm56	33
34	Bm2	Bm13	Bm26	Bm34	Bm62	Bm6	Bm12	Bm22	Bm47	Bm4	Bm12	Bm27	Bm57	34
35	Bm2	Bm14	Bm26	Bm36	Bm62	Bm6	Bm13	Bm22	Bm48	Bm4	Bm13	Bm27	Bm58	35
36	Bm3	Bm15	Bm27	Bm36	Bm65	Bm6	Bm14	Bm23	Bm49	Bm5	Bm14	Bm28	Bm60	36
37	Bm3	Bm15	Bm28	Bm37	-	Bm7	Bm15	Bm23	Bm49	Bm5	Bm14	Bm29	Bm72	37
38	Bm3	Bm16	Bm29	Bm37	-	Bm7	Bm15	Bm24	Bm50	Bm5	Bm15	Bm30	Bm72	38
39	Bm4	Bm16	Bm29	Bm38	-	Bm7	Bm15	Bm25	Bm50	Bm5	Bm15	Bm30	Bm61	39
40	Bm4	Bm16	Bm29	Bm38	-	Bm7	Bm15	Bm25	Bm51	Bm6	Bm15	Bm31	Bm65	40
41	Bm4	Bm17	Bm31	Bm39	-	Bm8	Bm16	Bm26	Bm51	Bm6	Bm16	Bm32	-	41
42	Bm4	Bm17	Bm31	Bm39	-	Bm8	Bm17	Bm26	Bm52	Bm6	Bm16	Bm34	-	42
43	Bm4	Bm18	Bm32	Bm40	-	Bm8	Bm17	Bm27	Bm52	Bm6	Bm17	Bm34	-	43
44	Bm4	Bm18	Bm32	Bm40	-	Bm8	Bm17	Bm27	Bm55	Bm7	Bm17	Bm34	-	44
45	Bm5	Bm18	Bm34	Bm41	-	Bm9	Bm18	Bm28	Bm56	Bm7	Bm18	Bm35	-	45
46	Bm5	Bm19	Bm35	Bm41	-	Bm9	Bm18	Bm29	Bm56	Bm7	Bm18	Bm36	-	46
47	Bm5	Bm19	Bm36	Bm42	-	Bm10	Bm18	Bm29	Bm57	Bm7	Bm18	Bm36	-	47
48	Bm5	Bm20	Bm36	Bm42	-	Bm10	Bm19	Bm29	Bm57	Bm7	Bm19	Bm37	-	48
49	Bm6	Bm20	Bm37	Bm55	-	Bm10	Bm19	Bm31	Bm58	Bm8	Bm19	Bm37	-	49
50	Bm6	Bm20	Bm37	Bm56	-	Bm10	Bm20	Bm31	Bm59	Bm8	Bm20	Bm38	-	50
51	Bm6	Bm20	Bm37	Bm56	-	Bm11	Bm20	Bm32	Bm60	Bm9	Bm20	Bm38	-	51
52	Bm6	Bm21	Bm38	Bm57	-	Bm11	Bm20	Bm34	Bm60	Bm9	Bm20	Bm38	-	52
53	Bm6	Bm21	Bm38	Bm57	-	Bm11	Bm21	Bm34	Bm72	Bm9	Bm21	Bm39	-	53
54	Bm7	Bm22	Bm38	Bm58	-	Bm12	Bm21	Bm34	Bm72	Bm9	Bm21	Bm39	-	54
55	Bm7	Bm22	Bm39	Bm58	-	Bm12	Bm22	Bm34	Bm61	Bm9	Bm22	Bm40	-	55
56	Bm7	Bm23	Bm39	Bm60	-	Bm12	Bm22	Bm36	Bm61	Bm10	Bm22	Bm40	-	56
57	Bm7	Bm23	Bm40	Bm60	-	Bm13	Bm23	Bm36	-	Bm10	Bm23	Bm40	-	57
58	Bm7	Bm23	Bm40	Bm60	-	Bm13	Bm23	Bm36	Bm65	Bm10	Bm23	Bm41	-	58
59	Bm7	Bm24	Bm40	Bm61	-	Bm14	Bm23	Bm37	-	Bm10	Bm23	Bm41	-	59
60	Bm8	Bm24	Bm41	Bm61	-	Bm14	Bm24	Bm37	Bm65	Bm10	Bm24	Bm42	-	60
61	Bm8	-	-	-	-	Bm15	-	-	-	Bm11	Bm24	Bm42	-	61
62	Bm9	-	-	-	-	Bm15	-	-	-	Bm11	Bm25	-	-	62
63	Bm9	-	-	-	-	Bm15	-	-	-	Bm11	Bm25	-	-	63
64	Bm9	-	-	-	-	Bm15	-	Bm38	Bm63	Bm11	Bm25	-	-	64
65	Bm9	-	-	-	-	Bm15	-	-	-	Bm12	Bm26	-	-	65
66	Bm9	-	-	-	-	Bm16	-	-	-	Bm12	Bm26	-	-	66
67	Bm10	-	-	-	-	Bm16	-	-	-	-	-	-	-	67
68	Bm10	-	-	-	-	Bm16	-	-	-	-	-	-	-	68
69	Bm10	-	-	-	-	Bm17	-	-	-	-	-	-	-	69
70	Bm10	-	-	-	-	Bm17	-	-	-	-	-	-	-	70
71	Bm10	-	-	-	-	Bm17	-	-	-	-	-	-	-	71
72	Bm10	-	-	-	-	Bm17	-	Bm41	-	-	-	-	-	72

Označení	Bočnice						
	Vnější Ø	Střední Ø	Vnitřní Ø	Tloušťka			
				0,5	1,0	1,5	2,5
Bm73	12	-	6	x	x		
Bm74	15	-	8	x	x		
Bm75	16	13	9	x	x		
Bm0	19,5	16	12	x	x		
Bm1	22	17	13	x	x		
Bm2	25	20	15	x	x		
Bm3	28	24	18	x	x		
Bm4	32	26	21,5	x	x		
Bm5	36	31	25	x	x	x	
Bm6	38	33	28	x	x	x	
Bm7	41	37	28	x	x	x	
Bm8	47	40	33		x	x	
Bm9	48	40	37		x	x	
Bm10	51	46	40		x	x	
Bm11	54	48	43		x	x	
Bm12	57	52	42		x	x	
Bm13	60	54	47		x	x	
Bm14	63	55	48		x	x	
Bm15	66	58	52		x	x	
Bm16	72	63	54		x	x	
Bm17	75	68	60		x	x	
Bm18	80	71	62		x	x	
Bm19	83	76	68		x	x	
Bm20	87	80	72		x	x	
Bm21	91	83	76		x	x	
Bm22	93	88	80		x	x	
Bm23	97	93	83		x	x	
Bm24	105	97	87		x	x	
Bm25	106	98	90		x	x	
Bm26	113	104	95		x	x	
Bm27	118	108	100		x	x	
Bm28	119	113	103		x	x	
Bm29	127	122	104		x	x	
Bm30	127	119	111		x	x	
Bm31	131	124	115		x	x	
Bm32	135	128	119		x	x	
Bm34	143	-	120		x	x	
Bm35	147	-	130		x	x	
Bm36	152	143	124		x	x	
Bm37	160	-	136		x	x	
Bm38	168	161	148		x	x	
Bm39	174	165	140			x	
Bm40	182	-	165			x	
Bm41	194	-	160			x	
Bm42	200	194	173			x	

Označení	Bočnice						
	Vnější Ø	Střední Ø	Vnitřní Ø	Tloušťka			
				0,5	1,0	1,5	2,5
Bm43	136	-	100			x	x
Bm44	140	-	110			x	x
Bm45	145	-	114			x	x
Bm46	155	140	120			x	x
Bm47	162	148	125			x	x
Bm48	168	-	148			x	x
Bm49	176	158	135			x	x
Bm50	182	-	133			x	x
Bm51	191	175	155			x	x
Bm52	200	-	173			x	x
Bm55	210	-	170			x	x
Bm56	213	-	185			x	x
Bm57	225	-	190			x	x
Bm58	236	-	200			x	x
Bm60	240	-	194			x	x
Bm61	255	-	225			x	x
Bm62	260	-	213			x	x
Bm63	290	-	250			x	x
Bm64	300	-	255			x	x
Bm65	275	-	240			x	x
Bm69	335	-	290			x	x
Bm72	250	-	213			x	x
Bm106	96	-	75			x	x
Bm107	110	-	86			x	x
Bm92	119	106	99			x	x
Bm108	127	122	104			x	x
Bm110	370	-	345			x	x

### Návrh konfigurace

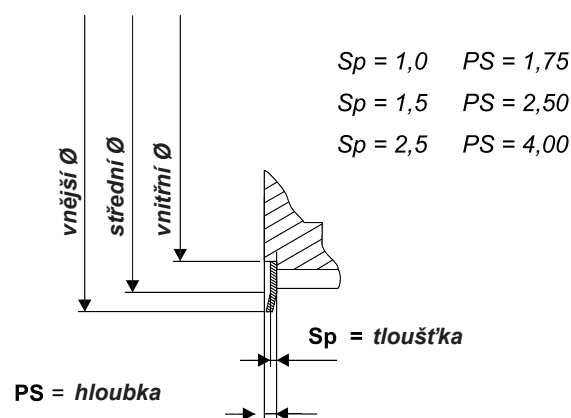

Vychýlení bočnice přibližně 15°

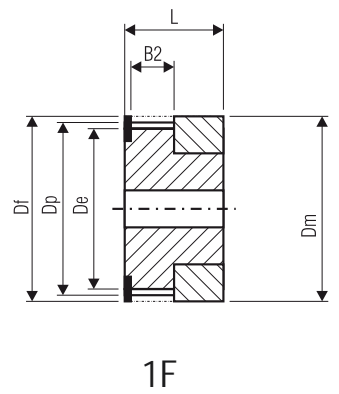
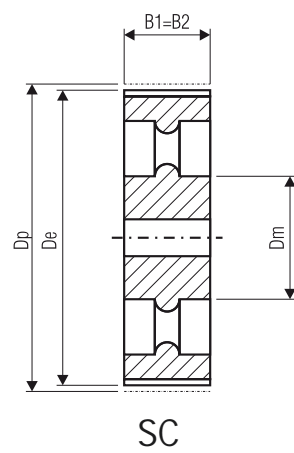
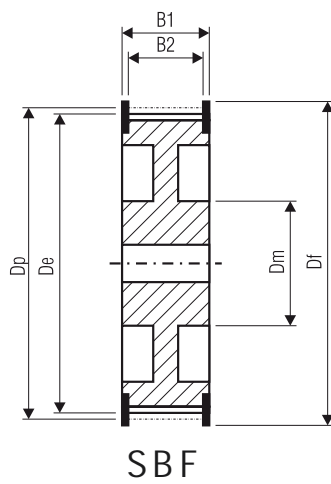
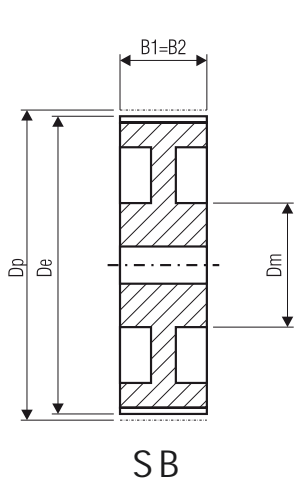
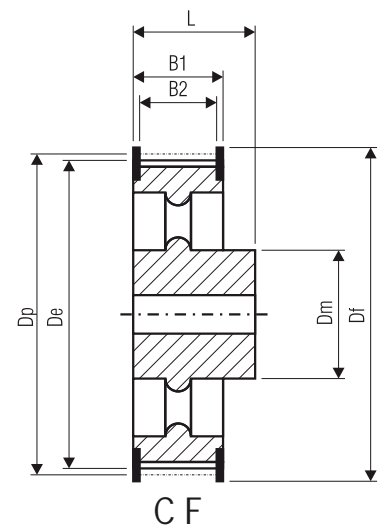
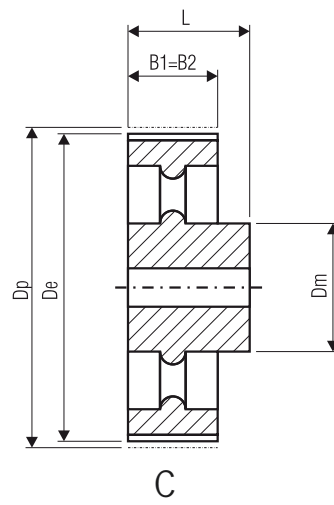
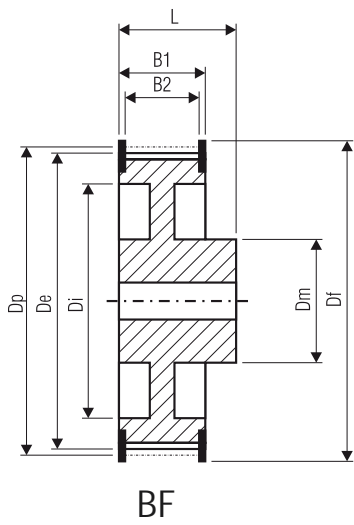
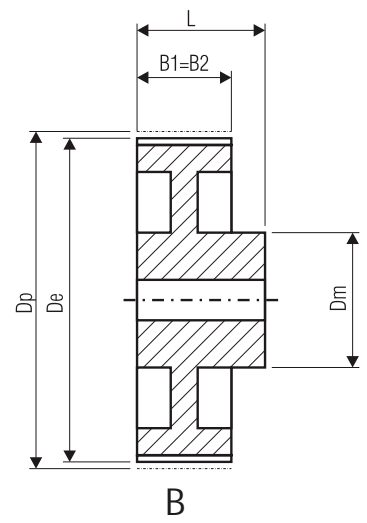
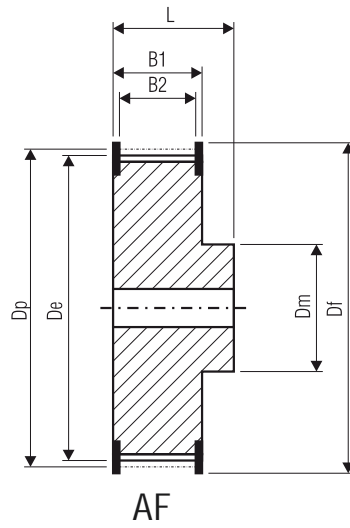
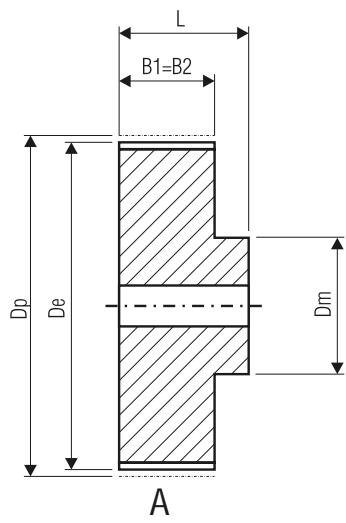



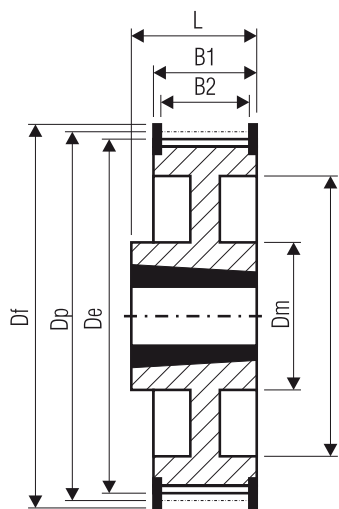

**8WF**

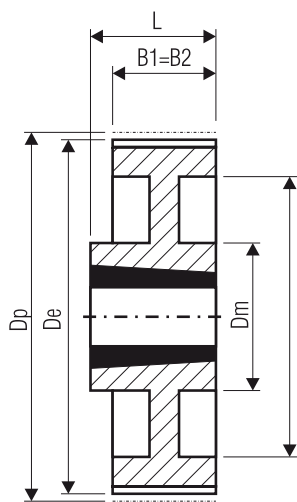

**8W**

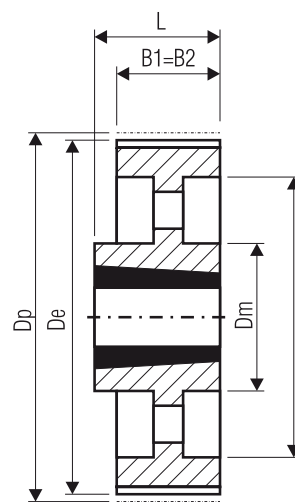

**8A**

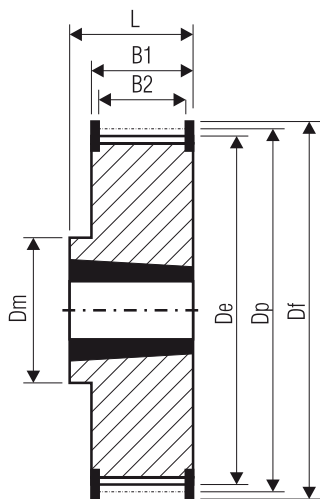

**8F**

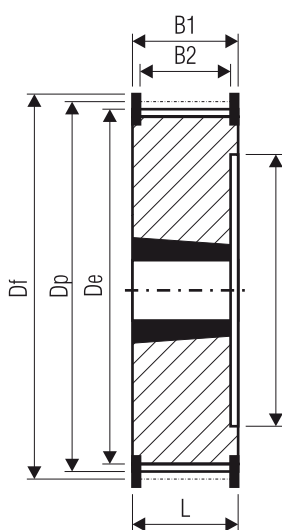

**5F**

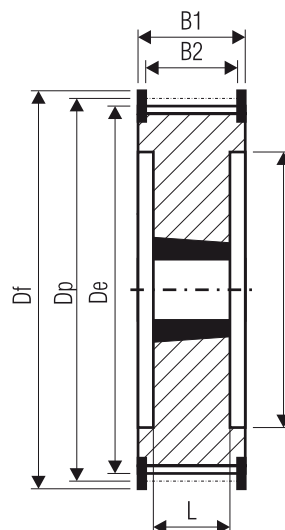

**4F**

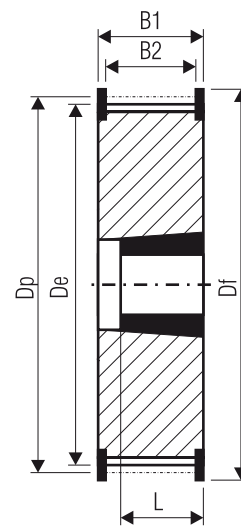

**3F**

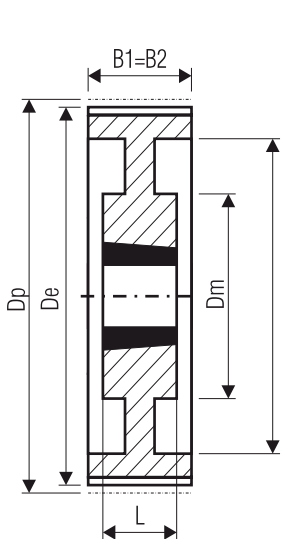

**9W**

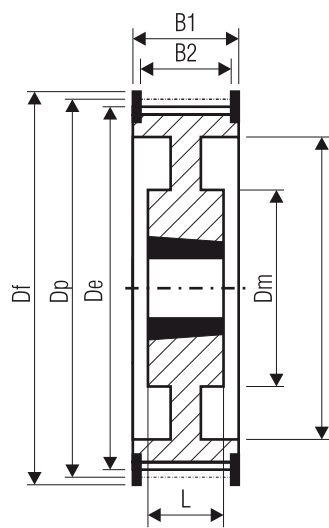

**9W F**

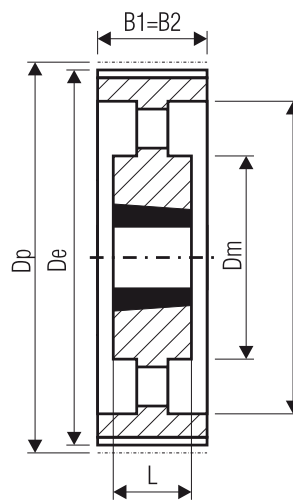

**9A**

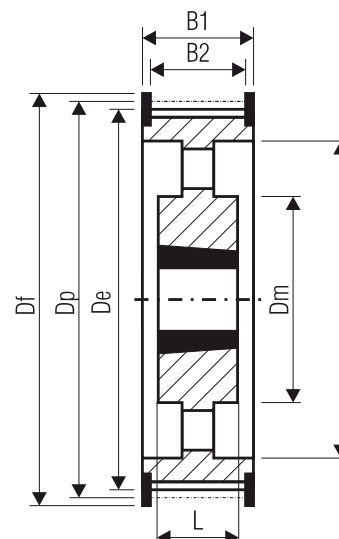

**9AF**

## Řemenice s nábojem bez bočnice - Typ (B)

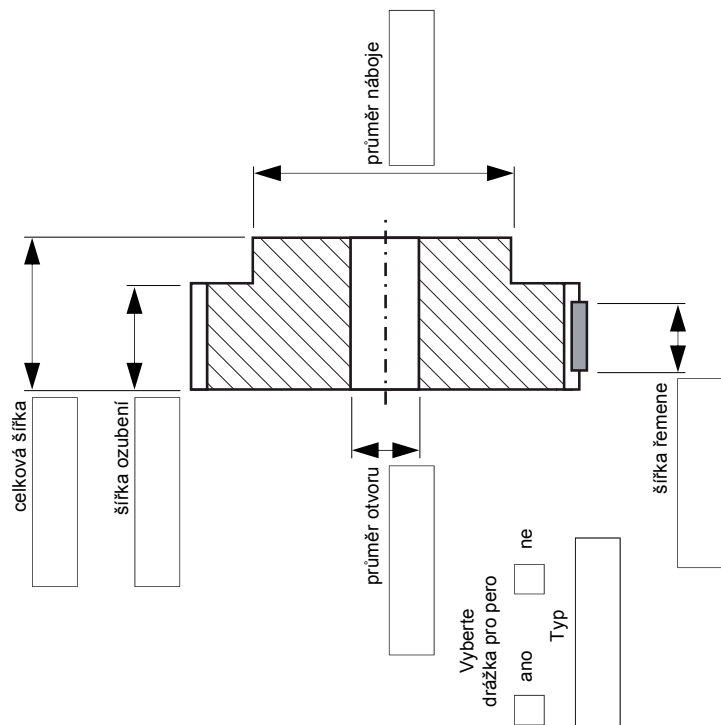

Materiál .....

Povrchová úprava .....

Počet zubů .....

Profil a rozteč .....

.....

Poznámka .....

.....

Vaše číslo poptávky .....

## Řemenice s nábojem a bočnicemi - Typ (A)

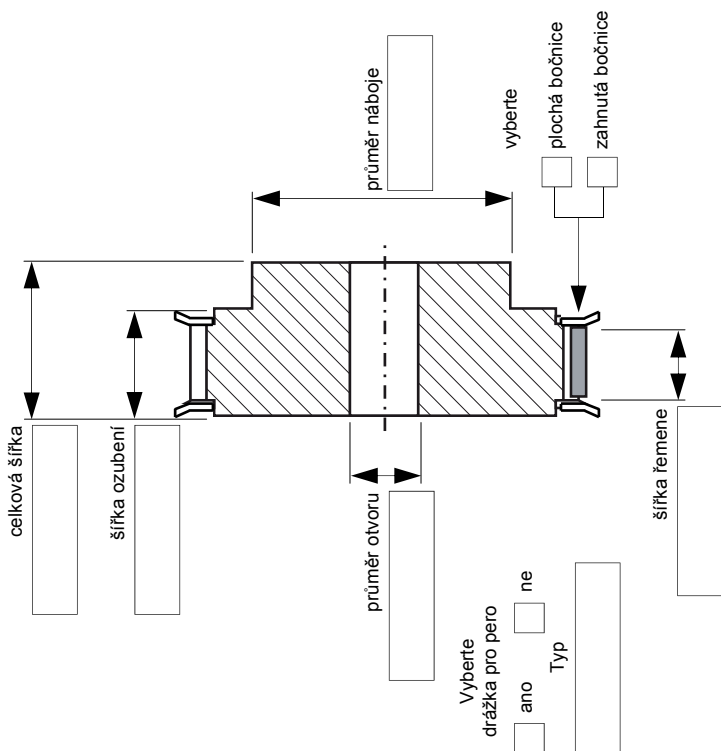

Materiál .....

Povrchová úprava .....

Počet zubů .....

Profil a rozteč .....

Označení bočnice .....

Poznámka .....

.....

Vaše číslo poptávky .....

**Řemenice bez náboje a bočnic - Typ (D)**

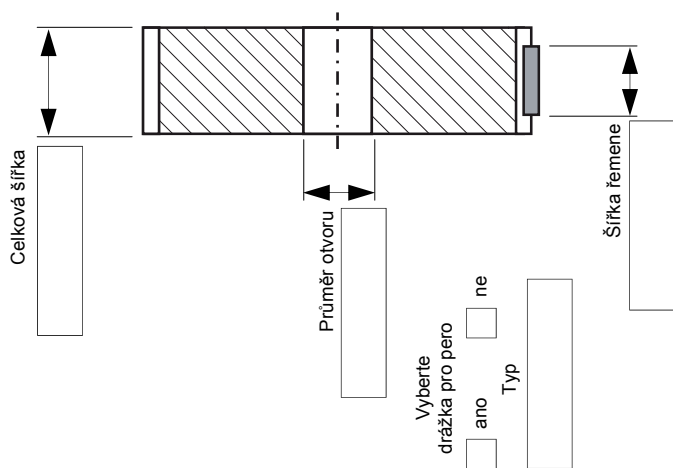

Materiál .....

Povrchová úprava .....

Počet zubů .....

Profil a rozteč .....

.....

Poznámka .....

.....

**Vaše číslo poptávky** .....

**Řemenice bez náboje s bočnicemi - Typ (C)**

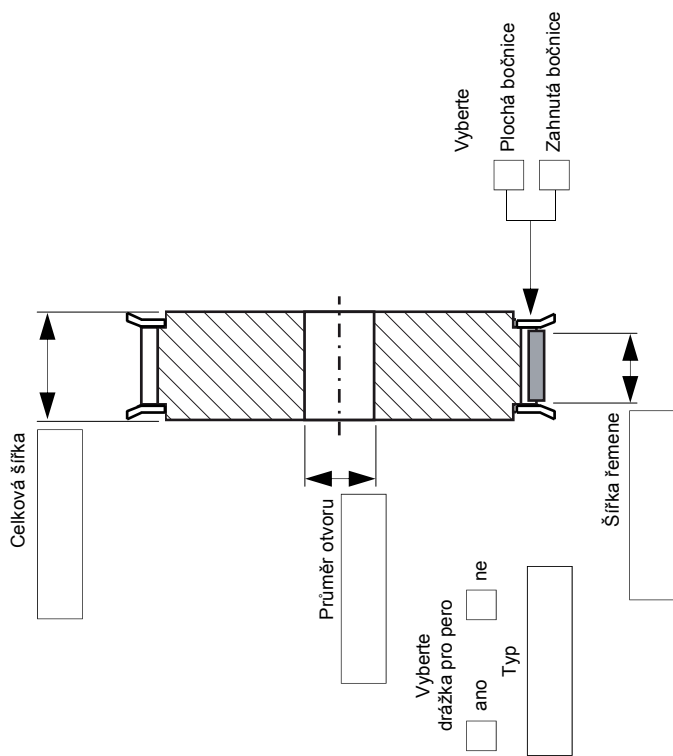

Materiál .....

Povrchová úprava .....

Počet zubů .....

Profil a rozteč .....

.....

Poznámka .....

.....

**Vaše číslo poptávky** .....



## PŘEHLED PRODUKTŮ

Všeobecný přehled kompletního výrobního sortimentu Megadyne



## MEGALINEAR PU OZUBENÉ ŘEMENY

Manuál pro výpočet PU řemenů Megalinear

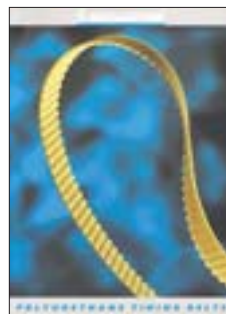

## POLYURETANOVÉ OZUBENÉ ŘEMENY

Manuál pro výpočet PU řemenů Megapower



## MEGAFLEX

Manuál pro výpočet PU řemenů Megaflex

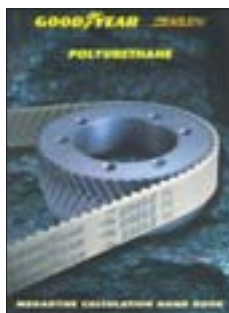

## EAGLE PD

Manuál pro výpočet PU řemenů Eagle



## ŘEMENY PRO TEXTILNÍ STROJE

Vzorník s PU TT řemeny pro tkalcovské stroje



## MEGAFLAT

Vzorkovník pro ploché nekonečné řemeny



## RPP GOLD

Manuál pro výpočet řemenů ISORAN RPP GOLD



## RPP SILVER

Manuál pro výpočet řemenů ISORAN RPP SILVER



## EXTRA

Krátký úvod do sortimentu Megadyne Extra klínových řemenů

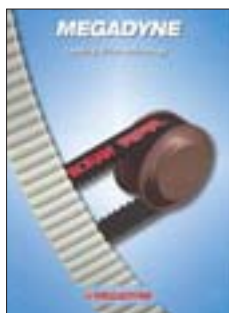

## LETÁK

Krátké seznámení s produkty Megadyne (vhodné pro výstavy)



## MEGAPULLEY

Přehledový katalog řemenic Megadyne



## PŘÍSTROJ PRO MĚŘENÍ NAPNUTÍ ŘEMENŮ RSM2005

Leták pro seznámení se s přístrojem RSM2005



## PU A NEOPRENOVÉ ŘEMENY - VÝPOČETNÍ PROGRAM

CD s výpočtním programem



## POSTER

Plakát představující kompletní sortiment Megadyne (vhodný do prodejen)



# MEGADYNE GROUP

## **MEGADYNE S.p.A.**

Via Trieste, 16 - 10075 MATHI (TO) - Italy  
PH: +39 011 9268052 FAX: +39 011 9268487  
e-mail: mail@megadyne.it

## **MEGADYNE S&D s.r.l.**

Corso Kennedy, 8 - 10070 ROBASSOMERO (TO) - Italy  
PH: +39 011 9241740 FAX: +39 011 9241746

## **MEGADYNE S&D VENETO s.r.l.**

Via Toniolo, 2/C Z.I. - 30030 MAERNE DI MARTELLAGO (VE) - Italy  
PH: +39 041 5030650 FAX: +39 041 5030784

## **MEGADYNE AMERICA LLC**

10348 Southern Loop Boulevard - PINEVILLE NC 28134 - USA  
PH: +1 704 5835388 FAX: +1 704 5835355

## **MEGADYNE CE Sp. z.o.o.**

Piekna 13 Street, 85-303 BYDGOSZCZ - Poland  
PH: +48 52 3487712 FAX: +48 52 3487715

## **MEGADYNE CHINA**

1/Floor, Building No. 4, Yong Hong Industrial Area, Da Fu South Road - Foshan GUANDONG 528000 - China  
PH: +86 757 83815530 FAX: +86 757 83828207

## **MEGADYNE CHINA**

Shanghai Branch Company-No. 68 Hang Xin Road, MinHang District 201105 SHANGHAI - China  
PH: +86 21 54471473 FAX: +86 21 54471447

## **MEGADYNE CHINA**

Qingdao Branch Company-Room No. 12-14 ChongQing Middle Road 197 - 266021 QINGDAO - China  
PH: +86 532 7652117 FAX: +86 532 7652197

## **MEGADYNE CZ**

Ocelářská čp. 891 - 19000 PRAGUE 9 - Czech Republic  
PH: +420 2 84817181 FAX: +420 2 84812486

## **MEGADYNE DO BRASIL LTDA**

Rua Maria Curupaiti 1169 Iimirim SP. CEP. 024252 - 002 SAO PAULO - Brasil  
PH: +5511 62361332 FAX: +5511 62366683

## **MEGADYNE EE**

St. K. Chornogo 31 - Office 901 - MINSK - Belarus  
PH: +375 17 2802486 FAX: +375 17 2856467

## **MEGADYNE FRANCE SA**

ZI LES BORDES - 15, Rue Gustave Madiot - 91923 BONDOUFLE CEDEX - France  
PH: +33 1 60798200 FAX: +33 1 60798201

## **MEGADYNE FRANCE Agence Sud**

66, Chemin Des Joncheres - 71850 CHARNAY LES MACON - France  
PH: +33 3385205810 FAX: +33 3385205811

## **MEGADYNE GmbH**

Nikolaus Otto - str. 24 - 33178 BORCHEN - Deutschland  
PH: +49 5251 87350 FAX: +49 5251 8735200

## **MEGADYNE U.K.**

Gildersome Spur - LEEDS - LS27 7JZ - U.K.  
PH: +44 11 32382910 FAX: +44 11 32383870

## **MEGADYNE HU Kft**

Mag u.3. 10/1 - 1214 BUDAPEST - Hungary  
PH: +36 14270406 FAX: +36 12785279

## **MEGADYNE RUBBER SA**

Ctra de l'Arboç, Km 1,7 - 08800 VILANOVA I LA GELTRÚ (BARCELONA) - Spain  
PH: +34 93 8115450 FAX: +34 93 8115470

## **MEGADYNE MIDDLE EAST FZCO**

P.O. BOX: 17366 - JEBAL ALI FZS - DUBAI - U.A.E.  
PH: +971 4 8860558 FAX: +971 4 8860559

## **MEGADYNE NORDIC AB**

Djupdalsvägen 16, SE-192 51 Sollentuna, Svezia.  
PH: +46 8 12029900 FAX: +46 8 12029999

## **JASON INDUSTRIAL Inc.**

340 Kaplan Drive, Fairfield, NJ 07004  
PH: 973-227-4904 FAX: 973-227-1651